

## **Biotechnology Explorer™**

### **pGLO™ Bacterial Transformation Kit**

**Catalog #166-0003EDU  
explorer.bio-rad.com**

**See individual components for storage temperature.**

**Duplication of any part of this document is permitted for classroom use only.  
Please visit [explorer.bio-rad.com](http://explorer.bio-rad.com) to access our selection of language translations  
for Biotechnology Explorer kit curricula.**

**BIO-RAD**

## **How can jellyfish shed light on the subject?**

One of the biggest challenges for first-time students of biotechnology or molecular biology is that many of the events and processes they are studying are invisible. The Biotechnology Explorer program has a solution: a gene from a bioluminescent jellyfish and its Green Fluorescent Protein—GFP. GFP fluoresces a brilliant green when viewed with a hand-held long-wave ultraviolet light (such as a pocket geology lamp).

The gene for GFP was originally isolated from the jellyfish, *Aequorea victoria*. The wild-type jellyfish gene has been modified by Maxygen Inc., a biotechnology company in Santa Clara, California. Specific mutations were introduced into the DNA sequence, which greatly enhance fluorescence of the protein. This modified form of the GFP gene has been inserted into Bio-Rad's pGLO plasmid and is now available exclusively from Bio-Rad for educational applications.

GFP is incredibly bright. Using pGLO to transform bacteria, students can actually observe gene expression in real time. Following the transformation with Bio-Rad's GFP purification kit, students purify the genetically engineered GFP from their transformed bacteria using a simple chromatography procedure. The entire process is visible using the hand-held UV lamp.

## **Guided Investigation**

The intent of this curriculum is to guide students through the thought process involved in a laboratory-based scientific procedure. The focus here is not so much on the answer or result, but rather on how the result was obtained and how it can be substantiated by careful observation and analysis of data. This is referred to as a guided inquiry-based laboratory investigation.

At each step along the way, student understanding of the process and the analysis of data is stressed. Instead of providing students with explanations or interpretations, the Student Manual poses a series of questions to focus and stimulate thinking about all aspects of the investigation. Answers are provided in the Instructor's Answer Guide.

Student involvement in this process will result in an increased understanding of the scientific process and the value of proceeding into a task in an organized and logical fashion. Furthermore, we are expecting that students who engage in this type of process will start to develop a more positive sense of their ability to understand the scientific method.

Bio-Rad's GFP-based curriculum is unique and has generated an unprecedented level of excitement among science educators. We strive to continually improve our curriculum and products. Your input is extremely important to us. We welcome your stories, comments, and suggestions.

Biotechnology Explorer Team  
Bio-Rad Laboratories  
6000 James Watson Drive  
Hercules, CA 94547  
Biotechnology\_Explorer@bio-rad.com

**Create context. Reinforce learning. Stay current.**

New scientific discoveries and technologies create more content for you to teach, but not more time. Biotechnology Explorer kits help you teach more effectively by integrating multiple core content subjects into a single lab. Connect concepts with techniques and put them into context with real-world scenarios.

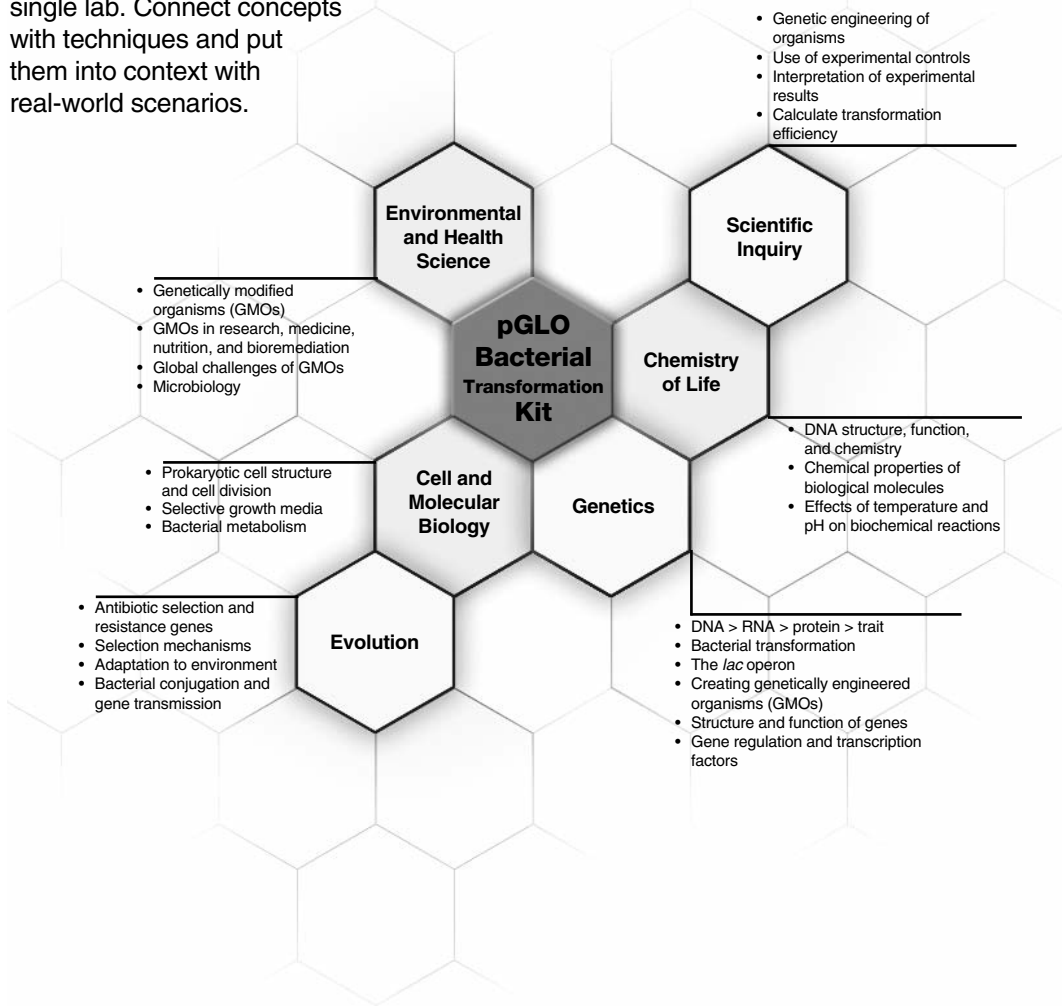



## Table of Contents

<b>Instructor's Guide</b>		<b>Page</b>
Introduction to Transformation .....		1
The pGLO System .....		1
Kit Inventory Checklist.....		2
Implementation Timeline .....		5
Safety Issues .....		5
Lesson Points to Highlight.....		6
General Laboratory Skills .....		6
Experimental Points – Optimizing your pGLO Lab Experiment .....		7
Conceptual Points .....		8
Instructor's Advance Preparation Overview.....		11
Workstation Checklist .....		11
Instructor's Advance Preparation Guide .....		13
Quick Guide (Graphic Laboratory Protocol).....		18
Instructor's Answer Guide .....		20
<b>Student Manual</b>		
Lesson 1	Introduction to Transformation.....	32
	Focus Questions .....	33
Lesson 2	Transformation Laboratory .....	36
	Review Questions .....	42
Lesson 3	Data Collection and Analysis.....	43
	Analysis of Results .....	44
	Review Questions .....	45
Lesson 4	Extension Activity: Calculate Transformation Efficiency .....	47
<b>Appendices</b>		
Appendix A	Historical Links to Biotechnology .....	53
Appendix B	Glossary of Terms .....	57
Appendix C	Basic Molecular Biology Concepts and Terminology .....	59
Appendix D	Gene Regulation .....	64
Appendix E	Photodocumentation of pGLO Plates using Vernier's BlueView Transilluminator.....	66
Appendix F	References .....	67





## Introduction to Transformation

In this lab, your students will perform a procedure known as genetic transformation. Genetic transformation occurs when a cell takes up (takes inside) and expresses a new piece of genetic material—DNA. This new genetic information often provides the organism with a new trait which is identifiable after transformation. Genetic transformation literally means change caused by genes and involves the insertion of one or more gene(s) into an organism in order to change the organism's traits.

Genetic transformation is used in many areas of biotechnology. In agriculture, genes coding for traits such as frost, pest, or drought resistance can be genetically transformed into plants. In bioremediation, bacteria can be genetically transformed with genes enabling them to digest oil spills. In medicine, diseases caused by defective genes are beginning to be treated by gene therapy; that is, by genetically transforming a sick person's cells with healthy copies of the defective gene that causes their disease.

Genes can be cut out of human, animal, or plant DNA and placed inside bacteria. For example, a healthy human gene for the hormone insulin can be put into bacteria. Under the right conditions, these bacteria can make authentic human insulin. This insulin can then be used to treat patients with the genetic disease, diabetes, because their insulin genes do not function normally.

## The pGLO System

With the pGLO transformation kit, students use a simple procedure to transform bacteria with a gene that codes for Green Fluorescent Protein (GFP). The real-life source of this gene is the bioluminescent jellyfish *Aequorea victoria*, and GFP causes the jellyfish to fluoresce and glow in the dark. Following the transformation procedure, the bacteria express their newly acquired jellyfish gene and produce the fluorescent protein which causes them to glow a brilliant green color under ultraviolet light.

In this activity, students will learn about the process of moving genes from one organism to another with the aid of a plasmid. In addition to one large chromosome, bacteria naturally contain one or more small circular pieces of DNA called plasmids. Plasmid DNA usually contains genes for one or more traits that may be beneficial to bacterial survival. In nature, bacteria can transfer plasmids back and forth, allowing them to share these beneficial genes. This natural mechanism allows bacteria to adapt to new environments. The recent occurrence of bacterial resistance to antibiotics is due to the transmission of plasmids.

Bio-Rad's unique pGLO plasmid contains the gene for GFP and a gene for resistance to the antibiotic ampicillin. pGLO also incorporates a special gene regulation system that can be used to control expression of the fluorescent protein in transformed cells. The gene for GFP can be switched on in transformed cells simply by adding the sugar arabinose to the cell's nutrient medium. Selection for cells that have been transformed with pGLO DNA is accomplished by growth on antibiotic plates. Transformed cells will appear white (wild-type phenotype) on plates not containing arabinose, and fluorescent green when arabinose is included in the nutrient agar. The unique construction of pGLO allows educators and students, for the very first time, to easily explore mechanisms of gene regulation (Appendix D) and genetic selection. And, the entire process is observable with an inexpensive long-wave UV lamp or with the provided pen-light.

In order for your students to gain the most from this experiment, they should know what a gene is and understand the relationship between genes and proteins. For a more detailed discussion of these and other basic molecular biology concepts and terms, refer to the review provided in Appendix B.

This pGLO transformation kit provides the opportunity for additional activities involving purification of the recombinant fluorescent protein from transformed bacteria using the GFP chromatography kit (catalog # 166-0005EDU) and the separation of proteins expressed in *E. coli*, such as the GFP protein by using the pGLO SDS-PAGE Extension kit (catalog #166-0013EDU.)



## Kit Inventory Check (✓) List

This section lists the components provided in the bacterial transformation kit. It also lists required accessories. Each kit contains sufficient materials to outfit 8 student workstations. Use this as a checklist to inventory your supplies before beginning the experiments. All kit components can be stored at room temperature until use.

Kit Components	Number/Kit	(✓)
<i>E. coli</i> HB101 K–12, lyophilized	1 vial	<input type="checkbox"/>
Plasmid (pGLO), lyophilized, 20 µg	1 vial	<input type="checkbox"/>
Ampicillin, lyophilized, 30 mg	1 vial	<input type="checkbox"/>
L (+) Arabinose, lyophilized, 600 mg	1 vial	<input type="checkbox"/>
Transformation solution (50 mM CaCl <sub>2</sub> , pH 6.1), sterile, 15 ml	1 bottle	<input type="checkbox"/>
LB nutrient broth, sterile, 10 ml	1 bottle	<input type="checkbox"/>
LB nutrient agar powder, sterile (to make 500 ml), 20 g	1 pouch	<input type="checkbox"/>
Pipets, sterile, individually wrapped	50	<input type="checkbox"/>
Inoculation loops, sterile, 10 µl, packs of 10 loops	8 pks	<input type="checkbox"/>
Petri dishes, 60 mm, sterile packs of 20	2 pks	<input type="checkbox"/>
Multicolor microcentrifuge tubes, 2.0 ml	60	<input type="checkbox"/>
Foam micro test tube holders	8	<input type="checkbox"/>
UV pen light	1	<input type="checkbox"/>
Instruction manual (available online or printed manual available by request)	1	<input type="checkbox"/>

Required Accessories – Not included in this kit	Number/Kit	(✓)
Clock or watch to time 50 sec	1	<input type="checkbox"/>
Microwave oven	1	<input type="checkbox"/>
Temperature controlled water bath, 1–6 liter (catalog # 166-0504EDU)*	1	<input type="checkbox"/>
Thermometer that reads 42°C	1	<input type="checkbox"/>
1 L flask	1	<input type="checkbox"/>
500 ml graduated cylinder	1	<input type="checkbox"/>
Distilled water, 500 ml	1	<input type="checkbox"/>
Crushed ice, not cubed ice, and containers (foam cups work well)	1–8	<input type="checkbox"/>
10 ml of bleach (household variety), 10% solution	10 ml	<input type="checkbox"/>
Permanent marker pens	4–8	<input type="checkbox"/>

\* If a temperature controlled water bath is not available, obtain a container (foam is best) for hot water and use a hot plate or hot tap water to get the water to 42°C.

Optional Accessories	Number/Kit	(✓)
Vortexer	1	<input type="checkbox"/>
Micropipets, adjustable volume, 2–20 µl (catalog #166-0506EDU or 166-0551EDU)	1	<input type="checkbox"/>
Parafilm laboratory sealing film	1	<input type="checkbox"/>
2–20 µl pipet tips	1	<input type="checkbox"/>
37°C incubator oven (catalog #166-0501EDU)**	1	<input type="checkbox"/>
Vernier Blue Digital BioImaging System (BL-DBS)	1	<input type="checkbox"/>

\*\* If an incubator oven is not available, try using an electric blanket or construct a homemade incubator with a cardboard box and a low voltage light bulb inside. Otherwise incubate agar plates 48 hours to 72 hours at ambient room temperature (see General Lab Skills—Incubation).

<b>Catalog #</b>	<b>Product Description</b>
166-0555EDU	<b>pGLO Bacterial Transformation Kit Refill Package</b>
166-0405EDU	<b>pGLO Plasmid</b> , 20 µg, lyophilized
166-0406EDU	<b>Arabinose</b> , 600 mg, lyophilized
166-0407EDU	<b>Ampicillin</b> , 30 mg, lyophilized
166-0408EDU	<b><i>E. coli</i> strain HB101 K-12</b> , lyophilized
166-0409EDU	<b>Transformation Solution</b> , 15 ml
166-0421EDU	<b>LB broth</b> , 10 ml
166-0600EDU	<b>LB Nutrient Agar Powder</b> , 20 g, makes forty, 60 mm agar plates
166-0472EDU	<b>LB Nutrient Agar Powder</b> , 500 g, makes one thousand, 60 mm agar plates
166-0479EDU	<b>Jellyfish Foam Floating Racks</b> , 8 racks with 12 microcentrifuge tube wells
166-0500EDU	<b>Long-Wave UV Lamp</b> , 1
166-0530EDU	<b>UV Pen Light</b> , 1
166-0470EDU	<b>Petri Dishes</b> , 60 mm sterile, 500
166-0471EDU	<b>Inoculation Loops</b> , sterile, 80
166-0474EDU	<b>Disposable Plastic Transfer Pipets</b> , sterile, 500
166-0480EDU	<b>Disposable Plastic Transfer Pipets</b> , nonsterile, 500
166-0473EDU	<b>Colored 1.5 ml Micro Test Tubes</b> , 6 colors, 600
223-9480EDU	<b>EZ Micro™ Test Tubes</b> , 1.5 ml, natural, 500
223-9430EDU	<b>EZ Micro Test Tubes</b> , 2.0 ml, natural, 500
166-0033EDU	<b>Instruction Manual</b> (available online or printed manual available by request)

## **National Science Standards and pGLO Transformation.**

### **Science as Inquiry**

- Design and conduct scientific inquiry.  
Students will understand the need for controls for the experiment.
- Use technology and mathematics to improve investigations and communications.  
Students use mathematics to calculate transformation efficiency. They can evaluate differences in techniques based on efficiencies.

### **Life Science Standards**

#### **The Cell**

- Cells have particular structures that underlie their functions  
Students should understand the role and function of the cell membrane and how procedures in the lab are designed to get the plasmid across the cell membrane.
- Most cell functions involve chemical reactions.  
Transformation solution contains calcium chloride. Students should understand how this salt dissociates in solution to surround the charged DNA molecules.
- Cells store and use information to guide their functions.  
Students provide new information to the cell that allows it to make new proteins.
- Cell functions are regulated.  
The production of the GFP protein is regulated by the sugar arabinose
- In all organisms, the instructions for specifying the characteristics of the organism are carried in DNA.  
The plasmid introduced to the cell is a circular, autonomously replicating piece of DNA.
- Changes in DNA (mutations) occur spontaneously at low rates.  
Bacteria have the ability to change and survive in the presence of antibiotics.

#### **Biological Evolution**

- Species evolve over time.  
Bacteria evolved with plasmids to provide new genes and new proteins for survival.

#### **Interdependence of Organisms**

- Living organisms have the capacity to produce populations of infinite size, but resources are finite.  
Bacterial growth is limited as food depletes and waste increases in the petri dish.

#### **Science and Technology**

- Understand about science and technology  
Recombinant DNA Technology allows us to put genes from one species into another and have that species produce a new protein.

## Implementation Timeline

Each of the three lab sessions is designed to be carried out in consecutive 50 min periods. The detailed lab protocol can be found in the Student Manual.

### Suggested laboratory schedule for the students

Day 1	Setting the Stage	Lecture and discussion Student considerations 1–4
Day 2	Transformation Laboratory	Transform cells and spread plates Student laboratory focus questions
Day 3	Data Collection and Analysis	Observe transformants and controls Analyze and interpret results Student considerations
Day 4	Extension Activities	Calculate transformation efficiency  GFP chromatography kit (catalog #166-0005EDU)  pGLO SDS-PAGE Extension kit (catalog #166-0013EDU)

## Safety Issues

Some countries outside the U.S. may require a special license to use this kit. Please refer to your country's legislative authorities for proper guidelines.

The *Escherichia coli* bacteria HB101 K-12 strain contained in this kit is not a pathogenic organism like the *E. coli* strain O157 H7 that has sometimes been implicated in food poisoning. HB101 K-12 has been genetically modified to prevent its growth unless grown on an enriched medium. However, handling of the *E. coli* K-12 strain requires the use of standard Microbiological Practices. These practices include, but are not limited to, the following. Work surfaces are decontaminated once a day and after any spill of viable material. All contaminated liquid or solid wastes are decontaminated before disposal. All persons must wash their hands: (i) after they handle material containing bacteria, and (ii) before exiting the laboratory. All procedures are performed carefully to minimize the creation of aerosols. Mechanical pipeting devices are used, mouth pipetting is prohibited; eating, drinking, smoking, and applying cosmetics are not permitted in the work area; wearing protective eyewear and gloves is strongly recommended.

If an autoclave is not available, all solutions and components (loops and pipets) that have come in contact with bacteria can be placed in a fresh 10% bleach solution for at least 20 min for sterilization. A shallow pan of this solution should be placed at every lab station. No matter what you choose, all used loops and pipets should be collected for sterilization. Sterilize petri dishes by covering the agar with 10% bleach solution. Let the plate stand for 1 hr or more, and then pour excess plate liquid down the drain. Once sterilized, the agar plates can be double bagged and treated as normal trash. Safety glasses are recommended when using bleach solutions.

Ampicillin may cause allergic reactions or irritation to the eyes, respiratory system, and skin. In case of contact with eyes, rinse immediately with plenty of water and seek medical advice. Wear suitable protective clothing. Ampicillin is a member of the penicillin family of antibiotics. Those with allergies to penicillin or to any other member of the penicillin family of antibiotics should avoid contact with ampicillin.

Please obtain the Material Safety Data Sheets (MSDS) available from Bio-Rad by calling 800-424-6723 in the United States, or see [www.bio-rad.com](http://www.bio-rad.com) for further information on reagents in this kit. Please consult your local environmental health and safety regulations for proper disposal.

### **Ultraviolet (UV) Lamps**

Ultraviolet radiation can cause damage to eyes and skin. Shortwave UV light is more damaging than long-wave UV light. The Bio-Rad UV lamp recommended for this module is long-wave. If possible, use UV-rated safety glasses or goggles.

### **Lesson Points to Highlight**

This section describes experimental and conceptual points which may prove challenging to students. These points are extremely important to the overall outcome of the activity. Instructors should alert their students' attention to these points, and when possible, demonstrate the technique before the students attempt the procedure.

The most important thing for students to do is to put the correct components in the correct tubes and onto the correct plates. So, marking the tubes clearly and being prepared and organized is crucial for a smooth execution of the experiment. The Quick Guide is provided to organize the activity. This graphic laboratory protocol provides visual depictions of all laboratory steps used in the transformation procedure.

### **General Laboratory Skills**

#### **Sterile Technique**

With any type of microbiology technique (such as working with and culturing bacteria), it is important not to introduce contaminating bacteria into the experiment. Because contaminating bacteria are ubiquitous and are found on fingertips, benchtops, etc., it is important to avoid these contaminating surfaces. When students are working with the inoculation loops, pipets, and agar plates, you should stress that the round circle at the end of the loop, the tip of the pipet, and the surface of the agar plate should not be touched or placed onto contaminating surfaces. While some contamination will likely not ruin the experiment, students would benefit from an introduction to the idea of sterile technique. Using sterile technique is also an issue of human cleanliness and safety.

#### **Use of the Pipet**

Before beginning the laboratory sessions, point out the graduations on the pipette to the students. The 100  $\mu$ l and 250  $\mu$ l and 1 ml marks will be used as units of measurement throughout the labs.

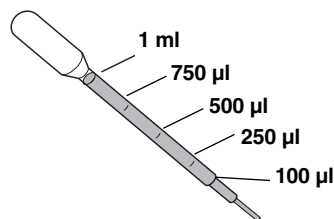

## Decontamination and Disposal

If an autoclave is not available, all solutions and components (loops and pipets) that have come in contact with bacteria can be placed in a fresh 10% bleach solution for at least 20 min for sterilization. A shallow pan of this solution should be placed at every lab station. No matter what you choose, all used loops and pipets should be collected for sterilization. Sterilize petri dishes by covering the agar with 10% bleach solution. Let it stand for 1 hr or more and then pour excess plate liquid down the drain. Once sterilized, the agar plates can be double bagged and treated as normal trash. Safety glasses are recommended when using bleach solutions. Please consult your local environmental health and safety regulations for proper disposal.

## Incubation

This guide is written to reflect the use of a 37°C incubator. The transformation experiment can be conducted without the use of an incubator, however, the number of days required to culture colonies to the optimum size depends on the ambient temperature. Best results are obtained if starter plate colonies are fresh (24–36 hr growth) and measure about 1–1.5 mm in diameter. **Refrigeration of cultured plates will significantly lower transformation efficiency.** The optimum temperature for growing *E. coli* is 37°C (98.6°F), and lower temperatures will result in a decreased growth rate. At 28°C (82°F), two days of incubation time are required to obtain optimum colony size. At 21°C (70°F), three days of incubation time are required to obtain optimum colony size. Adjust the advance preparation lead times and laboratory schedule according to your incubation temperature.

## Experimental Points – Optimizing Your pGLO Lab Experiment

### Practicing Techniques

Some educators like to do a dry run of the procedures to explain sterile technique, practice using the pipets and loops, and practice streaking and spreading bacteria on the agar's surface. You will have to decide what is best for your students based upon their laboratory experience and familiarity with these techniques. Paying close attention to the following experimental points will result in successful transformations.

### Preparing *E. coli* Starter (Agar) Plates

Best results are obtained when using a flask instead of a beaker to prepare the agar. Ensure that the agar is completely dissolved as uneven mixing can result in agar that will not solidify. Follow the directions in "Advance Preparation Step 1" closely to minimize introducing contaminants.

After the starter plates are streaked with *E. coli* and incubated at 37°C, they should be used within 24–36 hr. Delay beyond 36 hr will compromise transformation.

### Transferring Bacterial Colonies from Agar Plates to Microtubes

The process of scraping a single colony off the starter plate leads to the temptation to get more cells than needed. A single colony that is approximately 1 mm in diameter contains millions of bacterial cells. To increase transformation efficiency, students should select 2–4 "fat" colonies that are 1–1.5 mm in diameter. Selecting more than 4 colonies may decrease transformation efficiency. Select individual colonies rather than a swab of bacteria from the dense portion of the plate; the bacteria must be actively growing for transformation to be successful.

## DNA Transfer

The transfer of plasmid DNA from its stock tube to the transformation suspension is crucial. Students must look carefully at the loop to see if there is a film of plasmid solution across the ring. This is similar to seeing a soapy film across a wire ring for blowing soap bubbles. Optionally, the students may pipet 10  $\mu$ l of the pGLO plasmid into the tube labelled "+pGLO" and mix well.

## Heat Shock

The procedure used to increase the bacterial uptake of foreign DNA is called **heat shock**. It is important that students follow the directions regarding time. Also important is the rapid temperature change and the duration of the heat shock. For optimal results, the tubes containing the cell suspensions must be taken directly from ice, placed into the water bath at 42°C for 50 sec and returned immediately to the ice. The absence of the heat shock will result in a 10-fold decrease in transformants; 90 sec of heat shock will give about half as many transformants as will 50 sec of heat shock. In both cases, the experiment will work, but it has been optimized at 50 sec of heat shock. Be sure to use crushed ice, instead of cubed ice for maximum transformation efficiency. Use two thermometers to check the temperature of the incubator to ensure accuracy.

## Spreading Transformants and Controls

Delivering an excess of transformed culture to the plates with the disposable transfer pipet is counterproductive because the plates may not absorb the additional liquid and spreading will be uneven. Transferring bacterial suspensions from the microtubes to the petri dishes requires some care. The bacteria will settle to the bottom, so the students can hold the top of a closed tube between the index finger and thumb of one hand and flick the bottom of the tube with the index finger of the other hand. Be sure that students tap the tube with their finger or stir the suspension with the pipet before drawing it up. Also, make sure that the students cover the petri dishes with lids immediately after pipetting in the transformation culture and spreading the cells. Spread the suspensions evenly around the surface of the agar by quickly skating the flat surface of a new sterile loop back and forth across the plate surface.

## Green Fluorescent Protein (GFP) Chromatography Kit

If you plan to follow the pGLO bacterial transformation experiment with the GFP purification kit (catalog #166-0005EDU), you must save the pGLO-transformed bacteria grown on the LB/amp/ara plates. The best way to save the plates is to store them media-side up in a cool place, such as a refrigerator. This will keep the cells alive but limit their active growth until you need them to start the next experiment. Storing the plates upside down prevents condensed moisture from smearing the colonies on the media.

Ideally, plates should be used within 2–4 weeks. For longer storage, make sure that the plates are wrapped with Parafilm to prevent moisture loss.

## Conceptual Points

### Media

The liquid and solid nutrient media referred to as LB (named after Luria and Bertani) nutrient broth and LB nutrient agar are made from an extract of yeast and an enzymatic digest of meat byproducts, which provide a mixture of carbohydrates, amino acids, nucleotides, salts, and vitamins, as nutrients for bacterial growth. Agar, is derived from seaweed. It melts when heated, forms a solid gel when cooled (analogous to Jello-O), and functions to provide a solid support on which to culture bacteria.

### **Antibiotic Selection**

The pGLO plasmid, which contains the GFP gene, also contains the gene for beta-lactamase, which provides resistance to the antibiotic ampicillin, a member of the penicillin family. The beta-lactamase protein is produced and secreted by bacteria that contain the plasmid. Beta-lactamase inactivates the ampicillin present in the LB nutrient agar to allow bacterial growth. Only transformed bacteria that contain the plasmid and express beta-lactamase can grow on plates that contain ampicillin. Only a very small percentage of the cells take up the plasmid DNA and are transformed. Untransformed cells cannot grow on the ampicillin selection plates.

### **Transformation Solution**

It is postulated that the  $\text{Ca}^{2+}$  cation of the transformation solution (50 mM  $\text{CaCl}_2$ , pH 6.1) neutralizes the repulsive negative charges of the phosphate backbone of the DNA and the phospholipids of the cell membrane to allow the DNA to enter the cells.

### **Heat Shock**

The heat shock increases the permeability of the cell membrane to DNA. While the mechanism is not known, the duration of the heat shock is critical and has been optimized for the type of bacteria used and the transformation conditions employed.

### **Recovery**

The 10-min incubation period following the addition of LB nutrient broth allows the cells to recover and to express the ampicillin resistance protein beta-lactamase so that the transformed cells survive on the ampicillin selection plates.

The recovery culture can be incubated at room temperature or at  $37^\circ\text{C}$  for 1 hr to overnight. This can increase the transformation efficiency by more than 10-fold.

### **pGLO Gene Regulation**

Gene expression in all organisms is carefully regulated to allow adaptation to differing conditions and to prevent wasteful overproduction of unneeded proteins. The genes involved in the breakdown of different food sources are good examples of highly regulated genes. For example, the simple plant sugar arabinose is a source of both energy and carbon for bacteria. The bacterial genes that make digestive enzymes to break down arabinose for food are not expressed when arabinose is not in the environment. But when arabinose is present, these genes are turned on. When the arabinose runs out, the genes are turned off again.

Arabinose initiates transcription of these genes by promoting the binding of RNA polymerase. In the genetically engineered pGLO plasmid DNA, some of the genes involved in the breakdown of arabinose have been replaced by the jellyfish gene that codes for GFP. When bacteria that have been transformed with pGLO plasmid DNA are grown in the presence of arabinose, the GFP gene is turned on, and the bacteria glow brilliant green when exposed to UV light.



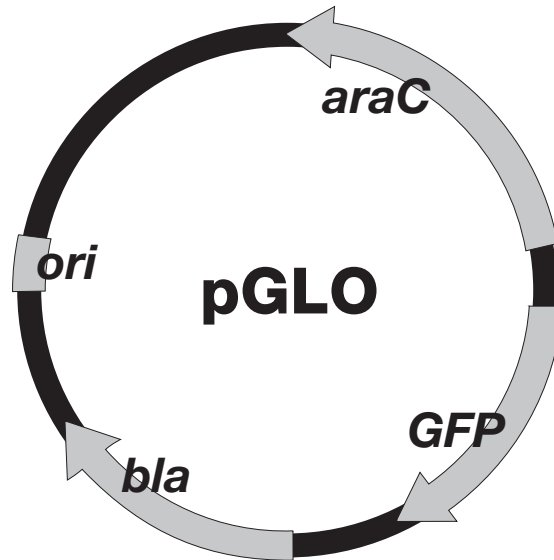

**pGLO plasmid.** Sequence and map are available at <http://explorer.bio-rad.com> under "Teaching Resources"

This is an excellent example of the central molecular framework of biology in action; that is, DNA→RNA→PROTEIN→TRAIT. When arabinose is absent from the growth media, the GFP gene remains turned off and the colonies appear white. A more detailed description and analysis of gene regulation and the function of the arabinose promoter can be found in Appendix A.

## Instructor's Advance Preparation Overview

This section outlines the recommended schedule for advance preparation on the part of the instructor. The detailed advance preparation guide is provided on pages 13–17.

Teacher preparation	When	Time
Step 1 Read through the transformation manual Make a copy of Student Manual and Quick Guide for each student	Immediately	1 hr
Step 2 Prepare nutrient agar plates	3–7 days prior	1 hr
Step 3 Prepare starter plates, aliquot solutions	36–48 hr prior	30 min
Step 4 Organize student workstations	Immediately prior	10 min

## Workstation (✓) Checklist

**Student workstations.** Materials and supplies that should be present at each student workstation prior to beginning the lab experiments are listed below. The components provided in this kit are sufficient for 8 complete student workstations.

**Common workstation.** A list of materials, supplies, and equipment that should be present at a common location accessible by all student groups is also listed below. It is up to the discretion of the teacher as to whether students should access common buffer solutions and equipment or whether the teacher should aliquot solutions in the microtubes provided.

### Lesson 2 Transformation Lab

#### Student workstation

Material	Quantity
<i>E. coli</i> starter plate (LB)	1
Poured agar plates (1 LB, 2 LB/amp, 1 LB/amp/ara)	4
Transformation solution	1
LB nutrient broth	1
Inoculation loops	7 (1 pk of 10)
Pipets	5
Foam microtube holder/float	1
Containers (such as foam cups) full of crushed ice (not cubed ice)	1
Marking pen	1
Microcentrifuge tubes	2

#### Common workstation

Material	Quantity
Rehydrated pGLO plasmid DNA	1 vial
42°C water bath and thermometer	1
UV light	1
37°C incubator	1
(optional, see General Laboratory Skills–Incubation)	1
2–20 µl adjustable volume micropipets	1
2–20 µl micropipet tips	1

### Lesson 3 Data Collection and Analysis

#### Student workstation

<b>Material</b>	<b>Quantity</b>
Incubated transformation and control plates:	Set of 4
LB/amp/ara	1
LB/amp	2
LB	1

#### Common workstation

<b>Material</b>	<b>Quantity</b>
UV lamp	1-8

## Instructor's Advance Preparation Guide

Objectives	Time required	When
Step 1 Prepare agar plates	1 hr	3–7 days prior
Step 2 Rehydrate <i>E. coli</i>	2 min	36–48 hr prior
Streak starter plates	15 min	24–36 hr prior
Rehydrate pGLO plasmid DNA	2 min	0–36 hr prior
Step 3 Aliquot solutions	10 min	Immediately prior
Set up workstations	10 min	

### Advance Preparation Step 1: 3–7 days before the Transformation Laboratory

#### 1. Prepare nutrient agar (autoclave-free)

The agar plates should be prepared at least three days before the student experiment is performed. They should be left out at room temperature for two days and then refrigerated until they are to be used. The two days on the benchtop allows the agar to dry out (cure) sufficiently to readily take up the liquid transformation solution in student lesson 2.

To prepare the agar, add 500 ml of distilled water to a 1 L or larger Erlenmeyer flask. Best results are obtained when using a flask, not a beaker. Add the entire contents of the LB nutrient agar packet. Swirl the flask to dissolve the agar, and heat to boiling in a microwave. Repeat heating and swirling about three times until all the agar is dissolved (**no more clear specks swirl around**), but be careful to allow the flask to cool a little before swirling so that the hot medium does not boil over onto your hand. Uneven mixing of the agar can result in agar not setting.

When all the agar is dissolved, allow the LB nutrient agar to cool so that the outside of the flask is just comfortable to hold (50°C). While the agar is cooling, label the plates and prepare the arabinose and ampicillin as outlined below (Step 3). Be careful not to let the agar cool so much that it begins to solidify. Keeping the flask with molten agar in a waterbath set to 50°C can help prevent the agar from cooling too quickly.

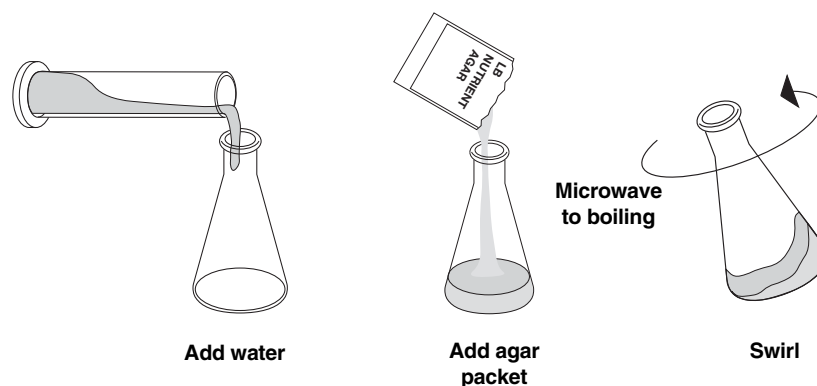

A microwave is the best way to dissolve the agar but if one is not available, a hot plate may be used. Take care not to boil to dryness and do simmer for 5–10 min after boiling to sterilize it.

## 2. Prepare arabinose and ampicillin

**Note:** Arabinose requires at least 10 min to dissolve—be patient.

Arabinose is shipped dry in a small vial. With a new sterile pipet, add 3 ml of transformation solution directly to the vial to rehydrate the sugar. Mix the vial; a vortexer helps. (Transformation solution is being used here because it is a handy sterile solution. Sterile water would work just as well.) Discard pipet after use.

Ampicillin is also shipped dry in a small vial. With a new sterile pipet, add 3 ml of transformation solution directly to the vial to rehydrate the antibiotic. (Transformation solution is being used here because it is a handy sterile solution. Sterile water would work just as well).

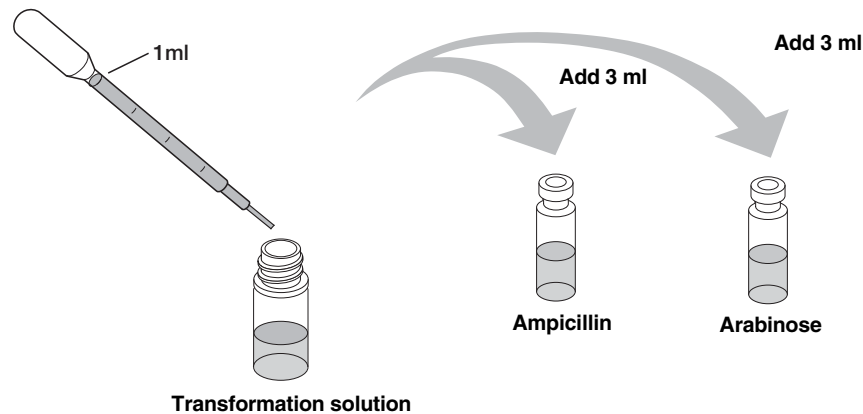

**Note:** Excessive heat ( $>60^{\circ}\text{C}$ ) will destroy the ampicillin and the arabinose, but the nutrient agar solidifies at  $27^{\circ}\text{C}$  so one must carefully monitor the cooling of the agar and then pour the plates from start to finish without interruption. Keeping the flask w/molten agar in a waterbath set to  $50^{\circ}\text{C}$  can help prevent the agar from cooling too quickly. Excess bubbles can be removed after all the plates are poured by briefly flaming the surface of each plate with the flame of a Bunsen burner. After the plates are poured do not disturb them until the agar has solidified. Pour excess agar in the garbage, not the sink. Wipe any agar drips off of the sides of the plates.

## 3. Label plates

The 40 supplied agar plates should be labelled with a permanent marker on the bottom close to the edge. Do not label the lids. Label 16 plates **LB**, 16 plates **LB/amp** and 8 plates **LB/amp/ara**.

**4. Pour LB nutrient agar plates (LB, LB/amp, LB/amp/ara)**

**First, pour LB nutrient agar into the 16 plates that are labeled LB.** Stack the empty plates 4 to 8 high and starting with the bottom plate lift the lid and the upper plates straight up and to the side with one hand and pour the LB nutrient agar with the other. Fill the plate about one-third to one-half (~12 ml) with agar, replace the lid and continue up the stack. Pour 16 plates in this fashion. Let the plates cool in this stacked configuration.

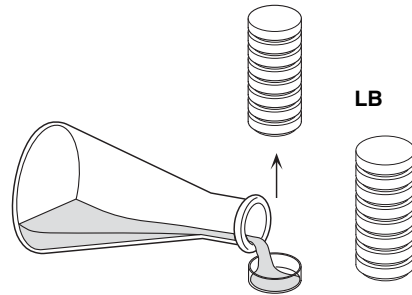

**Second, add the hydrated ampicillin to the remaining LB nutrient agar.** Swirl briefly to mix. Pour into the 16 plates that are labeled as **LB/amp** using the technique utilized above.

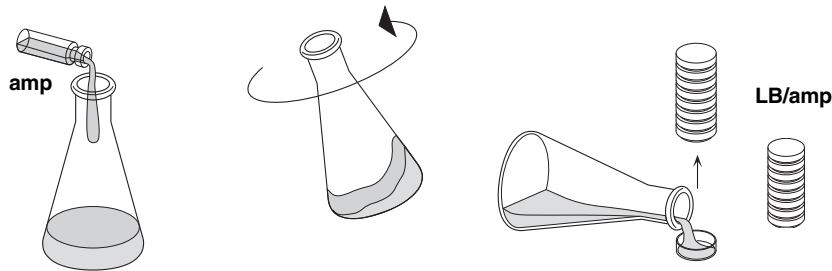

**Third, add the hydrated arabinose to the remaining LB nutrient agar containing ampicillin.** Swirl briefly to mix and pour into the 8 plates labeled as **LB/amp/ara** using the technique utilized above.

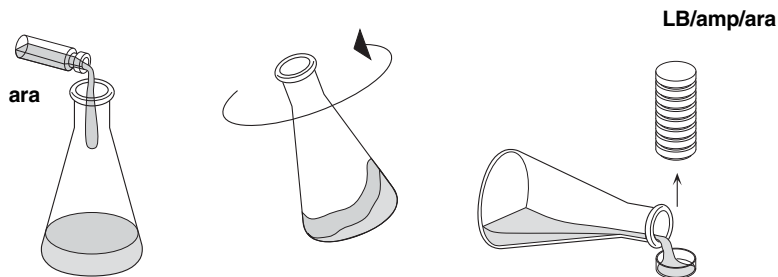

Plates should set within 30 minutes.

**5. Plate storage**

After the plates have cured for two days at room temperature they may either be used or stacked up twenty high in a plastic sleeve bag slipped back down over them. By covering the plates with the plastic bag the plates will stay hydrated. The stack is then inverted, the bag taped closed, and the plates stored upside-down at 4°C until used. The plates are inverted to prevent condensation on the lid, which may drip onto the agar.

## Advance Preparation Step 2: 24–36 hr before Transformation Laboratory

### 1. Rehydrate bacteria

Using a sterile pipet, rehydrate the lyophilized *E. coli* HB101 by adding 250  $\mu$ l of LB nutrient broth directly to the vial. Recap the vial and shake it gently to ensure all bacteria are rehydrated. Incubate the vial at 37°C for 8–24 hr. If an incubator or waterbath is not available, the vial can be placed into a large volume of water heated to 37°C and then left at room temperature for 16–24 hr. Store remaining LB broth at 4°C until use.

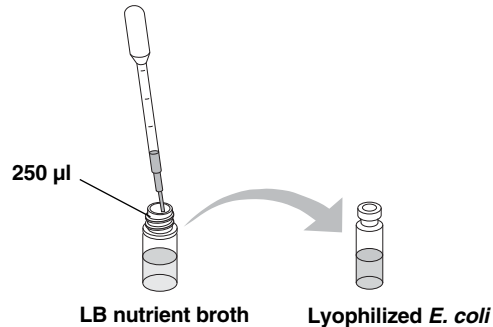

### 2. Streak starter plates to produce single bacterial colonies on agar plates

Each lab team will need their own starter plate as a source of cells for transformation. This kit contains sufficient material to outfit eight complete student workstations. LB plates should be streaked for single colonies and incubated at 37°C for 24–36 hr before the transformation activity is planned.

Using the rehydrated *E. coli* you prepared in the last step and eight **LB** agar plates (prepared in step one), streak one starter plate for each of your student teams. The purpose of streaking is to generate single colonies from a concentrated suspension of bacteria. A minute amount of the bacterial suspension goes a long way. Under favorable conditions, one cell multiplies to become millions of genetically identical cells in just 24 hr.

- Gently shake the vial of *E. coli* HB101 to resuspend the bacteria. Insert a sterile inoculation loop into the rehydrated bacterial culture. Insert the loop straight into the vial. Remove the loop and ensure a film of bacteria is across the loop. Streak the plates as illustrated below. Streaking takes place sequentially in four quadrants. The first streak is to just spread the cells out a little. Go back and forth with the loop about a dozen times in the small area shown. In subsequent quadrants the cells become more and more dilute, increasing the likelihood of producing single colonies.
- For subsequent streaks, the goal is to use as much of the surface area of the plate as possible. Rotate the plate approximately 45 degrees (so that the streaking motion is comfortable for your hand) and start the second streak. Do not dip into the rehydrated bacteria a second time. Go into the previous streak about two times and then back and forth as shown for a total of about 10 times.
- Rotate the plate again and repeat streaking.
- Rotate the plate for the final time and make the final streak. Repeat steps a–d with the remaining **LB** plates for however many student workstations there will be. Use the same inoculation loop for all plates. When you are finished with each plate, cover it immediately to avoid contamination.

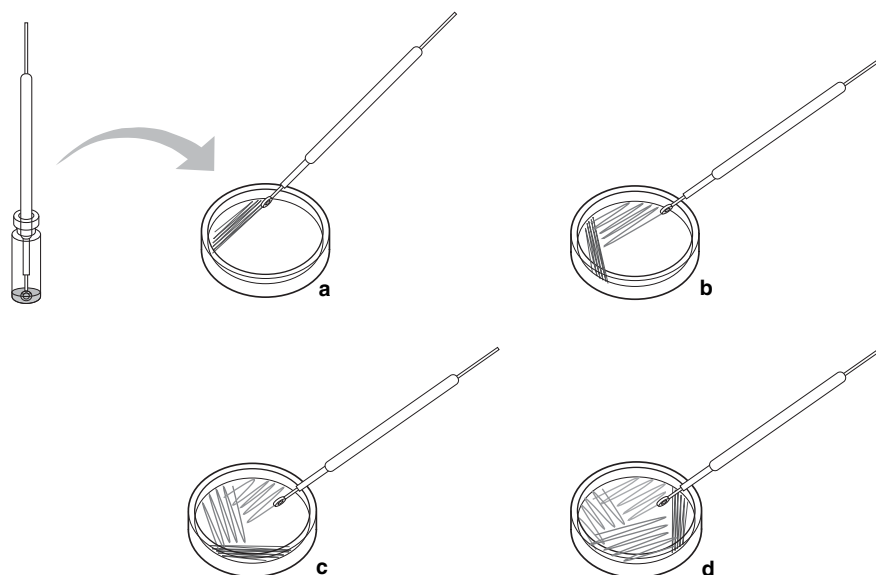

- e. Place the plates upside down inside the incubator overnight at 37°C or at room temperature for 2–3 days if an incubator is not available. Use for transformation within 24–36 hours as bacteria must be actively growing to achieve high transformation efficiency. Delaying more than 36 hours will compromise transformation. **DO NOT REFRIGERATE BEFORE USE.**
- f. *E. coli* forms off-white colonies that are uniformly circular with smooth edges. Avoid using plates with contaminant colonies.

### 3. Prepare pGLO plasmid

Using a new sterile pipet add 250 µl of transformation solution into the vial of lyophilized pGLO plasmid DNA. Note that the quantity of DNA is so small that the vial may appear empty. Invert the vial to mix plasmid solution well and ensure that the DNA is dissolved and is not sticking to the cap. If possible store the hydrated DNA in a refrigerator. (Transformation solution is being used here because it is a handy, sterile and nuclease-free solution. Sterile water would work just as well.)

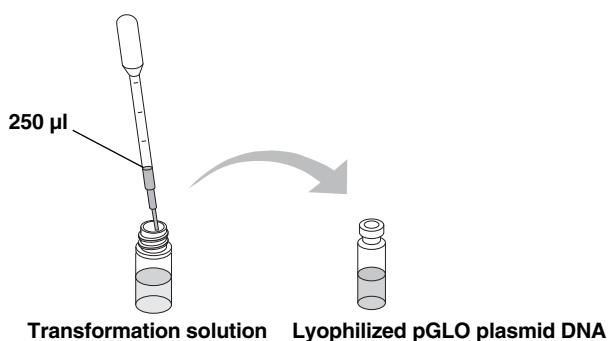

## Advance Preparation Step 3: Before Transformation Laboratory

### 1. Aliquot solutions

For each student workstation, aliquot 1 ml of transformation solution (CaCl<sub>2</sub>) and 1 ml of LB nutrient broth into separate color-coded 2 ml microtubes provided in the kit. If the LB nutrient broth is aliquoted 1 day prior to the lab it should be refrigerated. Label the tubes.

### 2. Set up workstations for transformation laboratory

See page 11 for materials to be supplied at each workstation.



## Transformation Kit—Quick Guide

1. Label one closed micro test tube +pGLO and another -pGLO. Label both tubes with your group's name. Place them in the foam tube rack.

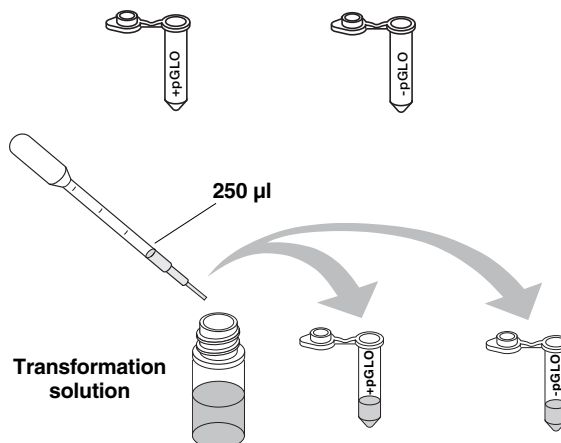

2. Open the tubes and using a sterile transfer pipet, transfer 250 µl of transformation solution (CaCl<sub>2</sub>) into each tube.

3. Place the tubes on crushed ice. Do not use cubed ice.

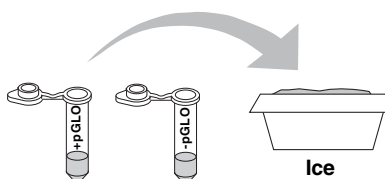

4. Use a sterile loop to pick up a single colony of bacteria from your starter plate. Pick up the +pGLO tube and immerse the loop into the transformation solution at the bottom of the tube. Spin the loop between your index finger and thumb until the entire colony is dispersed in the transformation solution (with no floating chunks). Place the tube back in the tube rack in the ice. Using a new sterile loop, repeat for the -pGLO tube.

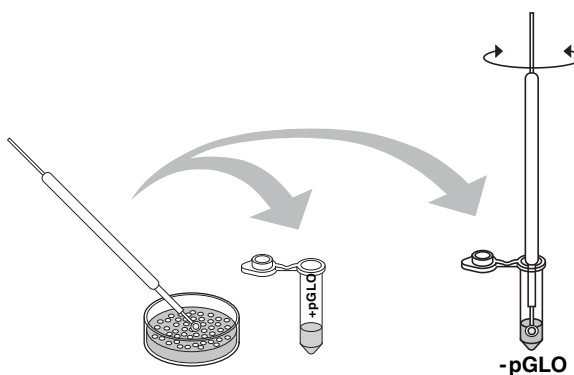

5. Examine the pGLO plasmid DNA solution with the UV lamp. Note your observations. Immerse a new sterile loop into the plasmid DNA stock tube. Withdraw a loopful. There should be a film of plasmid solution across the ring. This is similar to seeing a soapy film across a ring for blowing soap bubbles. Mix the loopful into the cell suspension of the +pGLO tube. Optionally, pipet 10 µl of pGLO plasmid into the +pGLO tube and mix. Close the -pGLO tube and return it to the rack on ice. Do not add plasmid DNA to the -pGLO tube. Why not? Close the -pGLO tube and return it to the rack on ice.

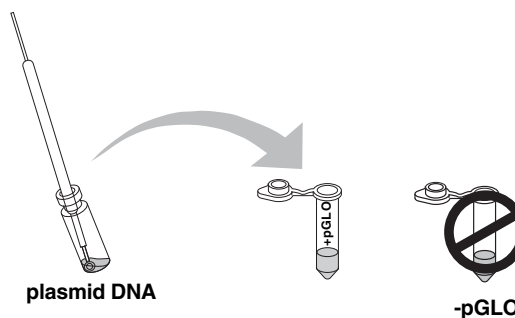

6. Incubate the tubes on ice for 10 min. Make sure to push the tubes all the way down in the rack so the bottom of the tubes stick out and make contact with the ice.

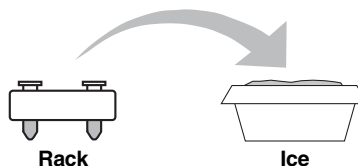

7. While the tubes are sitting on ice, label your four agar plates on the bottom (not the lid) as shown on the diagram.



8. Heat shock. Using the foam rack as a holder, transfer both the (+) pGLO and (-) pGLO tubes into the water bath, set at 42°C, for **exactly** 50 seconds. Make sure to push the tubes all the way down in the rack so the bottom of the tubes stick out and make contact with the warm water. When the 50 seconds have passed, place both tubes back on ice. For the best transformation results, the change from the ice (0°C) to 42°C and then back to the ice **must be rapid**. Incubate tubes on ice for 2 min.

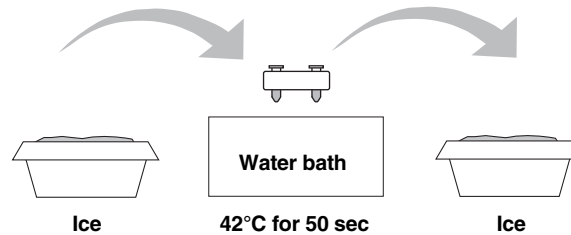

9. Remove the rack containing the tubes from the ice and place on the bench top. Open a tube and, using a new sterile pipet, add 250 µl of LB nutrient broth to the tube and reclose it. Repeat with a **new sterile pipet** for the other tube. Incubate the tubes for 10 min at room temperature.

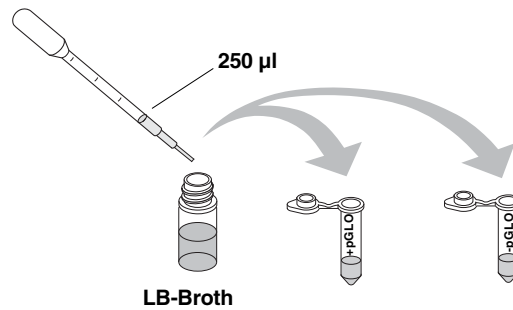

10. Gently flick the closed tubes with your finger to mix. Using a **new sterile pipet for each tube**, pipet 100 µl from each of the tubes to the corresponding plates, as shown on the diagram onto the appropriate plates.

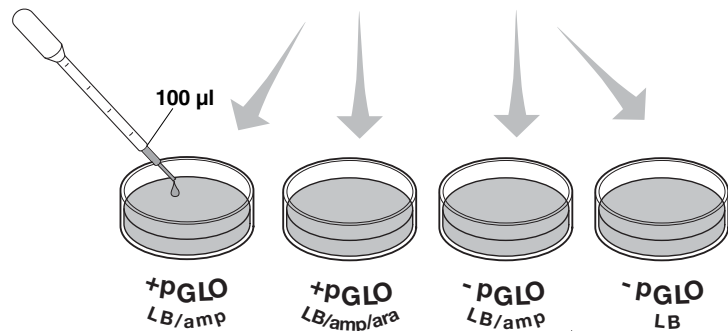

11. Use a **new sterile loop for each plate**. Spread the suspensions evenly around the surface of the agar by quickly skating the flat surface of a new sterile loop back and forth across the plate surface.

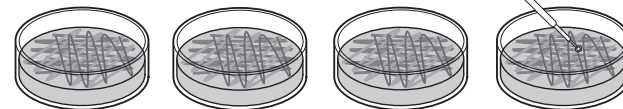

12. Stack up your plates and tape them together. Put your group name and class period on the bottom of the stack and place the stack **upside down** in the 37°C incubator until the next day.

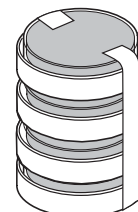

## Instructor's Answer Guide

### Lesson 1 Focus Questions

1. To genetically transform an entire organism, you must insert the new gene(s) into every cell in the organism. Which organism is better suited for total genetic transformation—one composed of many cells, or one composed of a single cell?

**A single-celled organism would be the best recipient for a genetic transformation, because it contains only one cell which needs to take up the new gene.**

2. Scientists often want to know if the genetically transformed organism can pass its new traits on to its offspring and future generations. To get this information, which would be a better candidate for your investigation, an organism in which each new generation develops and reproduces quickly, or one which does this more slowly?

**An organism which reproduces quickly. Fast production of offspring or new progeny will allow you to quickly assess if the new trait has been passed on.**

3. Safety is another important consideration in choosing an experimental organism. What traits or characteristics should the organism have (or not have) to be sure it will not harm you or the environment?

**The organism should not produce any toxins or compounds which could make people sick. The organism should grow vigorously in the lab environment, but should not be able to survive outside the laboratory. The organism should not be able to infect plants or animals.**

4. Based on the above considerations, which would be the best choice for a genetic transformation: a bacterium, earthworm, fish, or mouse? Describe your reasoning.

**A bacterium would be the best host organism. Bacteria are small, single-celled organisms which reproduce quickly and easily.**

**Note: The bacterium *Escherichia coli* (*E. coli*) strain HB101 K-12, best fits the requirements described above: it is made of only one cell, it reproduces every 20 minutes, it does not make people sick, and it cannot survive outside the laboratory.**

## Lesson 1 Consideration Questions

Recall that the goal of genetic transformation is to change an organism's traits (phenotype). Before any change in the phenotype of an organism can be detected, a thorough examination of its usual (pre-transformation) phenotype must be made. Look at the colonies of *E. coli* on your starter plates. List all observable traits or characteristics that can be described.

**Color of colonies, number of colonies, distribution of colonies on the plate.**

Describe how you could use two LB nutrient agar plates, some *E. coli*, and some ampicillin to determine how *E. coli* cells are affected by ampicillin.

**Equal amounts of cells could be plated on two different LB nutrient agar plates, one which contains just LB nutrient agar and one which contains LB nutrient agar ampicillin. The growth of *E. coli* could be compared on the two plates. If ampicillin negatively affects the growth of *E. coli*, then there should be fewer colonies of bacteria on that plate. If ampicillin has no effect, there should be approximately equal numbers of colonies on both plates.**

Results: What would you expect your experimental results to indicate about the effect of ampicillin on the *E. coli* cells?

**Antibiotics usually kill bacteria (are bacteriocidal) or inhibit their growth (bacteriostatic). Thus, there should be few, if any, bacterial colonies present on the ampicillin plate. The presence of any colonies on the ampicillin plate would suggest that those bacteria are resistant to the antibiotic ampicillin.**

## Lesson 2 Review Questions

1. On which of the plates would you expect to find bacteria most like the original untransformed *E. coli* colonies you initially observed? Explain your prediction.

**Bacteria which resemble the non-transformed will be found on the LB/(-) pGLO plate. These bacteria were removed from the starter plate, did not have any plasmid added to them, and were replated on an LB plate. Thus, they are virtually identical to the non-transformed starter .**

2. If there are any genetically transformed bacterial cells, on which plate(s) would they most likely be located? Explain your prediction.

**The transformed cells are found on the LB/amp and LB/amp/ara plates. Genetically transformed cells have taken up the pGLO plasmid which expresses the ampicillin resistance gene—these cells can survive on the plates which contain ampicillin.**

3. Which plates should be compared to determine if any genetic transformation has occurred? Why?

**The LB/amp (-) pGLO and the LB/amp (+) pGLO plates should be directly compared. Cells which were not treated with DNA (-pGLO) should not be expressing the ampicillin resistance gene and will not grow on the LB/amp plates. Cells which were treated with DNA (+pGLO) should contain the pGLO plasmid and should express the ampicillin resistance gene—the corresponding LB/amp plate will contain transformed bacterial colonies.**

4. What is meant by control plate? What purpose does a control serve?

**A control plate is a guide that is used to help you interpret the experimental results. In this experiment, both (-) pGLO plates are control plates. The LB/amp control plate can be compared to the LB/amp (+)pGLO plate. This comparison shows that genetic transformation produces bacterial colonies that can grow on ampicillin (due to the uptake of the pGLO plasmid and the expression of the ampicillin resistance gene). The (-) pGLO/LB control plate can be compared to any of the LB/amp plates to show that plasmid uptake is required for the growth in the presence of ampicillin. The (-) pGLO LB/amp plate shows that the starter culture does not grow on the LB/amp plate. Without this control one would not know if the colonies on the LB/amp (+) pGLO plate were really transformants.**

### Lesson 3 Data Collection and Analysis

1. Observe and draw what you see on each of the four plates. Put your drawings in the data table in the column on the right. Alternatively the protocol can incorporate digital documentation of the plates with Vernier's Blue Digital BioImaging System (Appendix E). Record your data to allow you to compare observations of the "+ pGLO" cells with those you record for the untransformed *E. coli*. Write down the following observations for each plate.

2. How much bacterial growth do you see on each, relatively speaking?

**There should be multiple colonies on both the LB/amp and LB/amp/ara plates that received the pGLO plasmid (approximately ~ 75 colonies). There should be no growth on the LB/amp (-) pGLO plate. There should be a lawn of bacteria on the LB (-) pGLO plate.**

3. What color are the bacteria?

**The bacteria on the (+) pGLO LB/amp plate and the (-) pGLO LB plates should be whitish. The bacteria on the (+) pGLO LB/amp/ara plate should appear whitish when exposed to normal, room lighting, but fluoresce bright green upon exposure to the long-wave UV light.**

4. Count how many bacterial colonies there are on each plate (the spots you see).

**There should be approximately ~ 75 bacterial colonies on the two (+) pGLO plates. The lawn of bacteria on the LB plate contains an even spread of bacteria and individual colonies can't be counted.**

Plates	Observations
+pGLO, LB/amp	Many transformed colonies of bacteria (approximately ~75). Colonies appear white.
+pGLO, Colonies LB/amp/ara	Many transformed colonies of bacteria (approximately ~75) appear white when exposed to room light but fluoresce bright green when exposed to UV light.
-pGLO, LB/amp	No bacterial growth present on this plate.
-pGLO, LB	An even lawn of bacteria is present on this plate. The lawn appears off-white.

### Lesson 3 Analysis of the Results

1. Which of the traits that you originally observed for *E. coli* did not seem to become altered? In the space below list these non-transformed traits and how you arrived at this analysis for each trait listed.

Original trait	Analysis of observations
Color	Bacteria are a whitish color
Colony size	Colony size is similar both before and after transformation

2. Of the *E. coli* traits you originally noted, which seem now to be significantly different after performing the transformation procedure? List those traits below and describe the changes that you observed.

New trait	Observed change
Color	The colonies on the LB/amp/ara plate fluoresce green under UV light
Ampicillin	The transformed colonies can grow on ampicillin resistance

3. If the genetically transformed cells have acquired the ability to live in the presence of the antibiotic ampicillin, then what can be inferred about the other genes on the plasmid that were involved in your transformation procedure?

**The plasmid must express a gene for ampicillin resistance (the protein product of the *bla* gene codes for beta-lactamase, the protein that breaks down ampicillin).**

4. From the results that you obtained, how could you prove that these changes that occurred were due to the procedure that you performed?

**The best way is to compare the control to the experimental plates. Cells that were not treated with the plasmid (LB/amp (-) pGLO and LB/amp/ara (-) pGLO plates) could not grow on ampicillin, whereas cells that were treated with the plasmid (LB/amp (+) pGLO and LB/amp/ara (+) pGLO plate) can grow on the LB/amp plate. Thus, the plasmid must confer resistance to ampicillin.**

## Lesson 3 Review Questions

### What's Glowing?

- 1 Recall what you observed when you shined the UV light source onto a sample of original pGLO plasmid DNA and describe your observations.

**The plasmid sample did not fluoresce.**

2. Which of the two possible sources of the fluorescence can now be eliminated?

**The pGLO plasmid DNA and the original bacteria can be eliminated from providing the fluorescent source.**

3. What does this observation indicate about the source of the fluorescence?

**The source of fluorescence is probably from some protein that the plasmid encodes.**

4. Describe the evidence that indicates whether your attempt at performing a genetic transformation was successful or not successful.

**A successful experiment will be represented by the presence of colonies on the (+) pGLO LB/amp and (+) pGLO LB/amp/ara plates and the absence of colonies on the (-) pGLO LB/amp plate. Moreover, the colonies on the LB/amp/ara plate should fluoresce green.**

**An unsuccessful experiment will show an absence of colonies on the (+) pGLO LB/amp and (+) pGLO LB/amp/ara plates. This could be a result of not adding a loopful of plasmid to the (+) pGLO tube or not adding a colony of bacteria to the (+) pGLO tube.**



## Lesson 3 Review Questions

### The Interaction between Genes and Environment

Look again at your four plates. Do you observe some *E. coli* growing on the LB plates which do not contain ampicillin/arabinose?

**Yes. The bacteria that did not receive the plasmid are growing on a plain LB plate.**

1. From your results, can you tell if these bacteria are ampicillin resistant by looking at them on the LB plate? Explain your answer.

**No. You cannot tell if the bacteria are ampicillin resistant just by looking at them. Both types of bacteria (those that are ampicillin resistant and those that are ampicillin sensitive) look similar when cultured—think about the colonies on the LB starter plate and the colonies on the +pGLO LB/amp plate.**

2. How would you change the bacteria's environment to best tell if they are ampicillin resistant?

**The best test would be to take some of the bacteria growing on the LB plate and streak them on an LB/amp plate. If the bacteria are viable on the LB/amp plate, then they are resistant to ampicillin. If no bacterial colonies survive, then they were not ampicillin resistant (they were ampicillin sensitive).**

3. Very often an organism's traits are caused by a combination of its genes and the environment it lives in. Think about the green color you saw in the genetically transformed bacteria:
  - a. What two factors must be present in the bacteria's environment for you to see the green color? (Hint: one factor is in the plate and the other factor is in how you look at the bacteria).

**The sugar arabinose in the agarose plate is needed to turn on the expression of the GFP gene. The UV light is necessary to cause the GFP protein within the bacteria to fluoresce.**

- b. What do you think each of the two environmental factors you listed above are doing to cause the genetically transformed bacteria turn green?

**The sugar arabinose turns on expression of the GFP gene by binding to a regulatory protein, *araC*, which sits on the P<sub>BAD</sub> promoter. When arabinose is present, it binds to *araC*, consequently changing the conformation of *araC* which facilitates transcription of the gene by RNA polymerase (see detailed description in Appendix D). When exposed to UV light, the electrons in GFP's chromophore are excited to a higher energy state. When they drop down to a lower energy state they emit a longer wavelength of visible fluorescent green light at 509 nm.**

- c. What advantage would there be for an organism to be able to turn on or off particular genes in response to certain conditions?

**Gene regulation allows for adaptation to differing conditions and prevents wasteful overproduction of unneeded proteins. Good examples of highly regulatable genes are the enzymes which break down carbohydrate food sources. If the sugar arabinose is present in the growth medium it is beneficial for bacteria to produce the enzymes necessary to catabolize the sugar source. Conversely, if arabinose is not present in the nutrient media, it would be very energetically wasteful to produce the enzymes to break down arabinose.**

## Lesson 4 Extension Activity

### 1. Determining the total number of green fluorescent cells.

Place your LB/amp/ara plate near a UV light source. Each colony on the plate can be assumed to be derived from a single cell. As individual cells reproduce, more and more cells are formed and develop into what is termed a colony. The most direct way to determine the **total number of green fluorescent cells** is to count the colonies on the plate.

Enter that number here →

Total number of cells =  
190

### 2. Determining the amount of pGLO plasmid DNA in the bacterial cells spread on the LB/amp/ara plate.

We need two pieces of information to find out the amount of DNA (pGLO) in the bacterial cells spread on the LB/amp/ara plate in this experiment. (i) What was the total amount of DNA we began the experiment with, and (ii) What fraction of DNA (in the bacteria) actually got spread onto the LB/amp/ara plates.

After you calculate this data, you will need to multiply the **total amount of pGLO plasmid DNA used** in this experiment by the fraction of DNA you spread on the LB/amp/ara plate. The answer to this multiplication will tell you the amount of pGLO plasmid DNA in the bacterial cells that were spread on the LB/amp/ara plate.

#### a. Determining the total amount of DNA

The total amount of pGLO plasmid DNA we began with is equal to the product of the concentration and the total volume used, or

$$\text{DNA } (\mu\text{g}) = (\text{concentration of DNA } (\mu\text{g}/\mu\text{l})) \times (\text{volume of DNA in } \mu\text{l})$$

In this experiment you used 10  $\mu\text{l}$  of pGLO at a concentration of 0.08  $\mu\text{g}/\mu\text{l}$ . This means that each microliter of solution contained 0.08  $\mu\text{g}$  of pGLO DNA. Calculate the **total amount of DNA used in this experiment**.

Enter that number here →

Total amount of DNA ( $\mu\text{g}$ )  
used in this experiment.=  
0.8

How will you use this piece of information?

**This number will be multiplied by the fraction of DNA used in order to determine the total amount of DNA spread on the agar plate.**

- b. **Determining the fraction of pGLO plasmid DNA (in the bacteria) that actually got spread onto the LB/amp/ara plate.** Since not all the pGLO plasmid DNA you added to the bacterial cells will be transferred to the agar plate, you need to find out what fraction of the DNA was actually spread onto the LB/amp/ara plate. To do this, divide the volume of DNA you spread on the LB/amp/ara plate by the total volume of liquid in the test tube containing the DNA. A formula for this statement is:

$$\text{Fraction of DNA used} = \frac{\text{Volume spread on LB/amp plate}}{\text{Total volume in test tube}}$$

You spread 100  $\mu\text{l}$  of cells containing pGLO DNA from a test tube containing a total volume of 510  $\mu\text{l}$  of solution. Do you remember why there is 510  $\mu\text{l}$  total solution? Look in the laboratory procedure and locate all the steps where you added liquid to the reaction tube. Add the volumes.

Use the above formula to calculate the **fraction of DNA** you spread on the LB/amp/ara plate.

Enter that number here →

Fraction of DNA =  
0.2

- How will you use this piece of information?

**This number will be multiplied by the amount of DNA used to calculate the amount of DNA spread on an agar plate.**

So, how many micrograms of DNA did you spread on the LB/amp/ara plates?

To answer this question, you will need to multiply the **total amount of DNA** used in this experiment by the **fraction of DNA** you spread on the LB/amp/ara plate.

$$\text{pGLO DNA spread } (\mu\text{g}) = \text{Total amount of DNA used } (\mu\text{g}) \times \text{fraction of DNA}$$

Enter that number here →

pGLO  
DNA spread ( $\mu\text{g}$ ) =  
0.16

- What will this number tell you?

**This number tells you how much DNA was spread on the agar plate.**

Look at all your calculations above. Decide which of the numbers you calculated belong in the table below. Fill in the following table:

Number of colonies on LB/amp/ara plate	190
Micrograms of pGLO DNA spread on the plates	0.16 $\mu\text{g}$

Now use the data in the table to calculate the efficiency of the pGLO transformation

$$\text{Transformation efficiency} = \frac{\text{Total number of cells growing on the agar plate}}{\text{Amount of DNA spread on the agar plate}}$$

Enter that number here →

<p><b>1187 transformants/<math>\mu\text{g}</math></b> Transformation efficiency</p>
---------------------------------------------------------------------------------------------

### Analysis

Transformation efficiency calculations result in very large numbers. Scientists often use a mathematical shorthand referred to as scientific notation. For example, if the calculated transformation efficiency is 1,000 bacteria/ $\mu\text{g}$  of DNA, they often report this number as:

**$10^3$  transformants/ $\mu\text{g}$**  ( **$10^3$  is another way of saying  $10 \times 10 \times 10$  or 1,000**)

- How would scientists report 10,000 transformants/ $\mu\text{g}$  in scientific notation?

**$10^4$**

Carrying this idea a little farther, suppose scientists calculated an efficiency of **5,000 bacteria/ $\mu\text{g}$  of DNA**. This would be reported as:

$5.0 \times 10^3$  transformants/ $\mu\text{g}$  (5 times 1,000)

- How would scientists report 40,000 transformants/ $\mu\text{g}$  in scientific notation?

**$4.0 \times 10^4$**

One final example: If 2,600 transformants/ $\mu\text{g}$  were calculated, then the scientific notation for this number would be:

$$2.6 \times 10^3 \text{ transformants}/\mu\text{g} \quad (2.6 \text{ times } 1,000)$$

Similarly:

$$5,600 = 5.6 \times 10^3 \quad 271,000 = 2.71 \times 10^5 \quad 2,420,000 = 2.42 \times 10^6$$

- How would scientists report 960,000 transformants/ $\mu\text{g}$  in scientific notation?  
 **$9.6 \times 10^5$**
- Report your calculated transformation efficiency in scientific notation.

$$1.2 \times 10^3 \quad \text{transformants}/\mu\text{g}$$

- Use a sentence or two to explain what your calculation of transformation efficiency means:

**Transformation efficiency is a quantitative value that describes how effective you were at getting a plasmid into bacteria. The number represents the number of transformed colonies produced per microgram of DNA added.**

Biotechnologists are in general agreement that the transformation protocol that you have just completed generally has a transformation efficiency of between  $8.0 \times 10^2$  and  $7.0 \times 10^3$  transformants per microgram of DNA.

- How does your transformation efficiency compare with the above?

**The calculated efficiency ( $1.2 \times 10^3$ ) is within the predicted limits of efficiency for this protocol.**

- In the table below, report the transformation efficiency of several of the teams in the class.

Team	Efficiency
<b>Answers will vary</b>	

- How does your transformation efficiency compare with theirs?

**Answers will vary.**

- Calculate the transformation efficiency of the following experiment using the information and the results listed below.

**DNA plasmid concentration—0.08 µg/µl**

**250 µl CaCl<sub>2</sub> transformation solution**

**10 µl plasmid solution**

**250 µl LB nutrient broth**

**100 µl cells spread on agar**

**227 colonies of transformants counted**

Fill in the following chart and show your calculations to your teacher.

Number of colonies on LB/amp/ara plate	227
Micrograms of DNA spread on the plates	0.16
Transformation efficiency	$1.4 \times 10^3$

- Extra Credit Challenge

If a particular experiment were known to have a transformation efficiency of  $3 \times 10^3$  bacteria/µg of DNA, how many transformant colonies would be expected to grow on the LB/amp/ara plate? You can assume that the concentration of DNA and fraction of cells spread on the LB agar are the same as that of the pGLO laboratory.

**Transformation efficiency = # colonies/DNA spread on plate (µg)**

$$3.0 \times 10^3 = X/0.16$$

$$(3.0 \times 10^3)(0.16) = X$$

$$480 = X$$

**480 transformant colonies**

# Student Manual

## pGLO Transformation

### Lesson 1 Introduction to Transformation

In this lab you will perform a procedure known as genetic transformation. Remember that a gene is a piece of DNA which provides the instructions for making (codes for) a protein. This protein gives an organism a particular trait. Genetic transformation literally means “change caused by genes,” and involves the insertion of a gene into an organism in order to change the organism’s trait. Genetic transformation is used in many areas of biotechnology. In agriculture, genes coding for traits such as frost, pest, or spoilage resistance can be genetically transformed into plants. In bioremediation, bacteria can be genetically transformed with genes enabling them to digest oil spills. In medicine, diseases caused by defective genes are beginning to be treated by gene therapy; that is, by genetically transforming a sick person’s cells with healthy copies of the defective gene that causes the disease.

You will use a procedure to transform bacteria with a gene that codes for Green Fluorescent Protein (GFP). The real-life source of this gene is the bioluminescent jellyfish *Aequorea victoria*. Green Fluorescent Protein causes the jellyfish to fluoresce and glow in the dark. Following the transformation procedure, the bacteria express their newly acquired jellyfish gene and produce the fluorescent protein, which causes them to glow a brilliant green color under ultraviolet light.

In this activity, you will learn about the process of moving genes from one organism to another with the aid of a plasmid. In addition to one large chromosome, bacteria naturally contain one or more small circular pieces of DNA called plasmids. Plasmid DNA usually contains genes for one or more traits that may be beneficial to bacterial survival. In nature, bacteria can transfer plasmids back and forth allowing them to share these beneficial genes. This natural mechanism allows bacteria to adapt to new environments. The recent occurrence of bacterial resistance to antibiotics is due to the transmission of plasmids.

Bio-Rad’s unique pGLO plasmid encodes the gene for GFP and a gene for resistance to the antibiotic ampicillin. pGLO also incorporates a special gene regulation system, which can be used to control expression of the fluorescent protein in transformed cells. The gene for GFP can be switched on in transformed cells by adding the sugar arabinose to the cells’ nutrient medium. Selection for cells that have been transformed with pGLO DNA is accomplished by growth on ampicillin plates. Transformed cells will appear white (wild-type phenotype) on plates not containing arabinose, and fluorescent green under UV light when arabinose is included in the nutrient agar medium.

You will be provided with the tools and a protocol for performing genetic transformation.

Your task will be to:

1. Do the genetic transformation.
2. Determine the degree of success in your efforts to genetically alter an organism.





## Consideration 2: How Can I Tell if Cells Have Been Genetically Transformed?

Recall that the goal of genetic transformation is to change an organism's traits, also known as their phenotype. Before any change in the phenotype of an organism can be detected, a thorough examination of its natural (pre-transformation) phenotype must be made. Look at the colonies of *E. coli* on your starter plates. List all observable traits or characteristics that can be described:

The following pre-transformation observations of *E. coli* might provide baseline data to make reference to when attempting to determine if any genetic transformation has occurred.

- a) Number of colonies
  
  - b) Size of :
    - 1) the largest colony
    - 2) the smallest colony
    - 3) the majority of colonies
  
  - c) Color of the colonies
  
  - d) Distribution of the colonies on the plate
  
  - e) Visible appearance when viewed with ultraviolet (UV) light
  
  - f) The ability of the cells to live and reproduce in the presence of an antibiotic such as ampicillin
1. Describe how you could use two LB/agar plates, some *E. coli* and some ampicillin to determine how *E. coli* cells are affected by ampicillin.
  
  
  
  
  
  
  
  
  
  
  2. What would you expect your experimental results to indicate about the effect of ampicillin on the *E. coli* cells?

### Consideration 3: The Genes

Genetic transformation involves the insertion of some new DNA into the *E. coli* cells. In addition to one large chromosome, bacteria often contain one or more small circular pieces of DNA called plasmids. Plasmid DNA usually contains genes for more than one trait. Scientists use a process called genetic engineering to insert genes coding for new traits into a plasmid. In this case, the pGLO plasmid has been genetically engineered to carry the GFP gene which codes for the green fluorescent protein, GFP, and a gene (*bla*) that codes for a protein that gives the bacteria resistance to an antibiotic. The genetically engineered plasmid can then be used to genetically transform bacteria to give them this new trait.

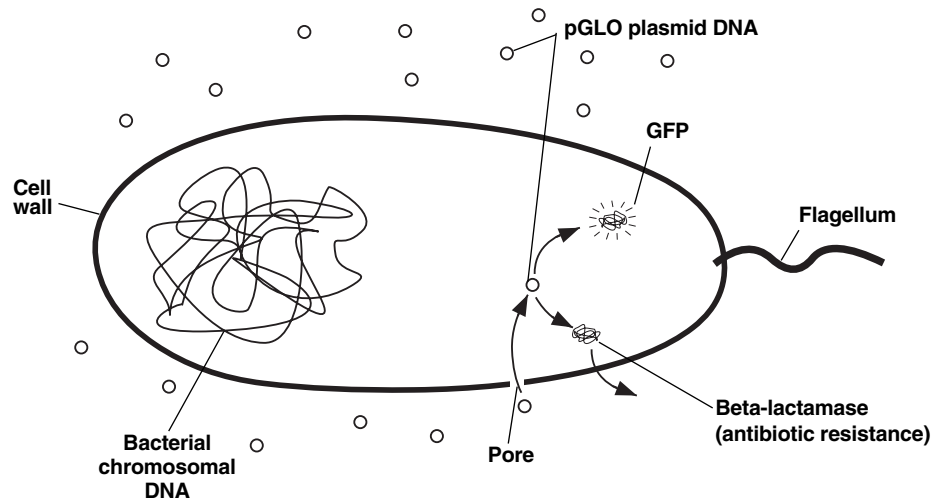

### Consideration 4: The Act of Transformation

This transformation procedure involves three main steps. These steps are intended to introduce the plasmid DNA into the *E. coli* cells and provide an environment for the cells to express their newly acquired genes.

#### To move the pGLO plasmid DNA through the cell membrane you will:

1. Use a transformation solution containing  $\text{CaCl}_2$  (calcium chloride).
2. Carry out a procedure referred to as **heat shock**.

#### For transformed cells to grow in the presence of ampicillin you must:

3. Provide them with nutrients and a short incubation period to begin expressing their newly acquired genes.

## Lesson 2 Transformation Laboratory

### Workstation (✓) Checklist

**Your workstation:** Materials and supplies that should be present at your workstation prior to beginning this lab are listed below.

#### Student workstation

Material	Quantity	(✓)
<i>E. coli</i> starter plate	1	<input type="checkbox"/>
Poured agar plates (1 LB, 2 LB/amp, 1 LB/amp/ara)	4	<input type="checkbox"/>
Transformation solution	1	<input type="checkbox"/>
LB nutrient broth	1	<input type="checkbox"/>
Inoculation loops	7 (1 pk of 10)	<input type="checkbox"/>
Pipets	5	<input type="checkbox"/>
Foam microcentrifuge tube holder/float	1	<input type="checkbox"/>
Container (such as foam cup) full of crushed ice (not cubed ice)	1	<input type="checkbox"/>
Marking pen	1	<input type="checkbox"/>
Copy of Quick Guide	1	<input type="checkbox"/>
Microcentrifuge tubes	2	<input type="checkbox"/>

**Common workstation.** A list of materials, supplies, and equipment that should be present at a common location to be accessed by your team is also listed below.

Material	Quantity	
Rehydrated pGLO plasmid	1 vial	<input type="checkbox"/>
42°C water bath and thermometer	1	<input type="checkbox"/>
UV Light	1	<input type="checkbox"/>
37°C incubator	1	<input type="checkbox"/>
(optional, see General Laboratory Skills—Incubation)		
2–20 µl adjustable volume micropipets	1	<input type="checkbox"/>
2–20 µl micropipet tips	1	<input type="checkbox"/>

### Transformation Procedure

1. Label one closed micro test tube **+pGLO** and another **-pGLO**. Label both tubes with your group's name. Place them in the foam tube rack.



2. Open the tubes and, using a sterile transfer pipet, transfer 250  $\mu$ l of transformation solution ( $\text{CaCl}_2$ ) into each tube.

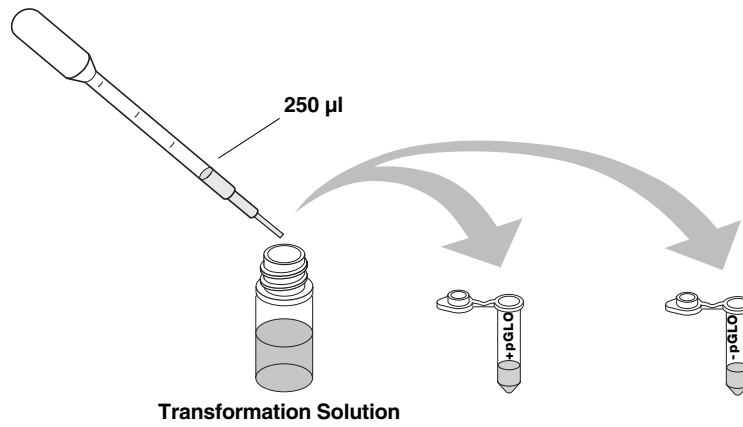

3. Place the tubes on ice.

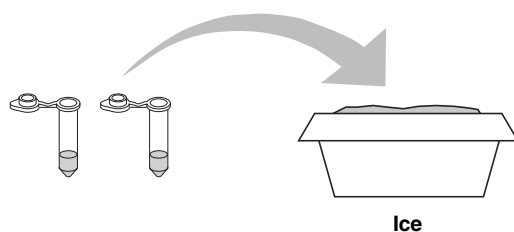

4. Use a sterile loop to pick up **2–4 large colonies of bacteria** from your starter plate. Select starter colonies that are "fat" (ie: 1–2 mm in diameter). It is important to take individual colonies (not a swab of bacteria from the dense portion of the plate), since the bacteria must be actively growing to achieve high transformation efficiency. Choose only bacterial colonies that are uniformly circular with smooth edges. Pick up the **+pGLO** tube and immerse the loop into the transformation solution at the bottom of the tube. Spin the loop between your index finger and thumb until the entire colony is dispersed in the transformation solution (with no floating chunks). Place the tube back in the tube rack in the ice. Using a new sterile loop, repeat for the **-pGLO** tube.

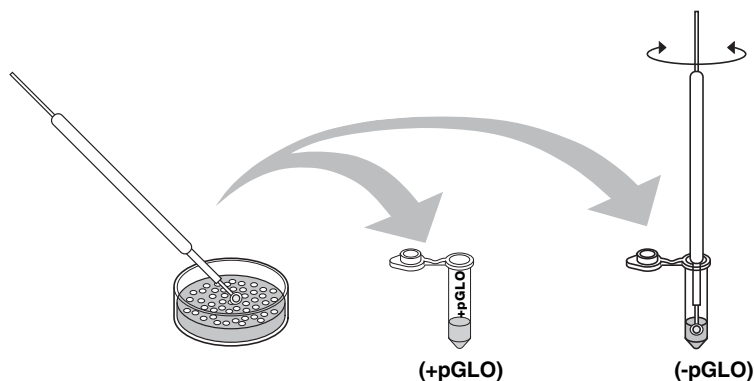

5. Examine the pGLO DNA solution with the UV lamp. Note your observations. Immerse a **new sterile loop** into the pGLO plasmid DNA stock tube. Withdraw a loopful. There should be a film of plasmid solution across the ring. This is similar to seeing a soapy film across a ring for blowing soap bubbles. Mix the loopful into the cell suspension of the **+pGLO** tube. Optionally, pipet 10  $\mu$ l of pGLO plasmid into the +pGLO tube & mix. **Do not** add plasmid DNA to the **-pGLO** tube. Close both the **+pGLO** and **-pGLO** tubes and return them to the rack on ice.

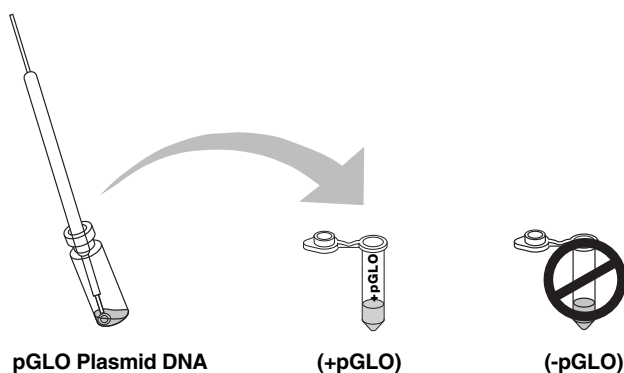



- Remove the rack containing the tubes from the ice and place on the bench top. Open a tube and, using a new sterile pipet, add 250  $\mu$ l of LB nutrient broth to the tube and reclose it. Repeat with a new sterile pipet for the other tube. Incubate the tubes for 10 min at room temperature.

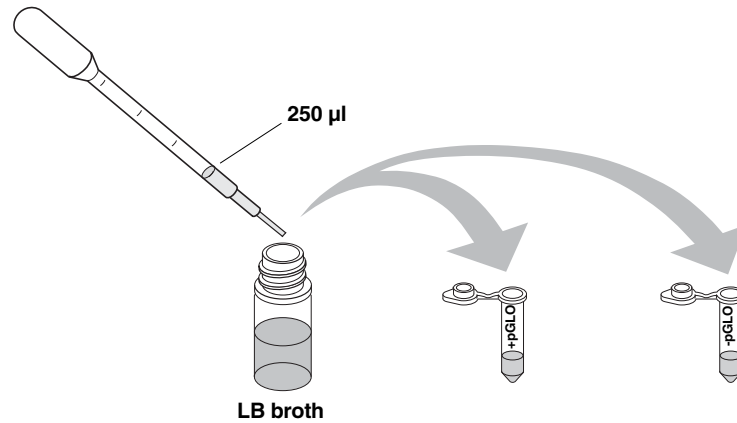

- Gently flick the closed tubes with your finger to mix and resuspend the bacteria. Using a new sterile pipet for each tube, pipet 100  $\mu$ l of the transformation and control suspensions onto the appropriate nutrient agar plates.

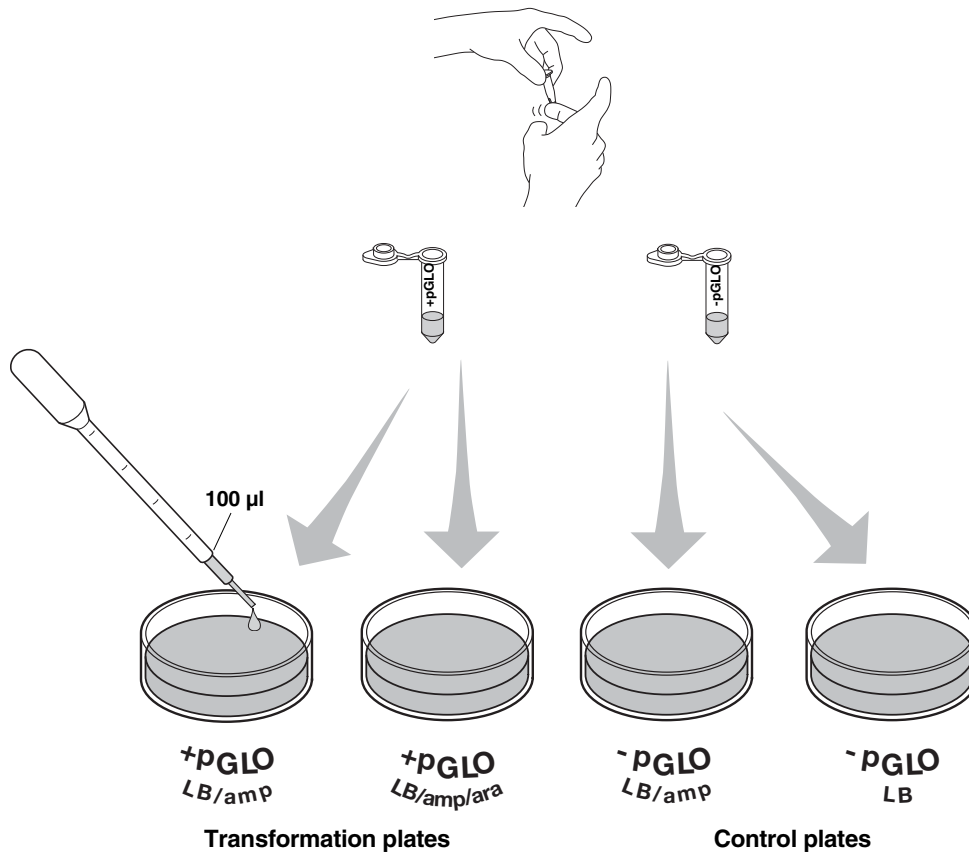

11. **Use a new sterile loop for each plate.** Spread the suspensions evenly around the surface of the LB nutrient agar by quickly skating the flat surface of a new sterile loop back and forth across the plate surface. **DO NOT PRESS TOO DEEP INTO THE AGAR.** Uncover one plate at a time and re-cover immediately after spreading the suspension of cells. This will minimize contamination.

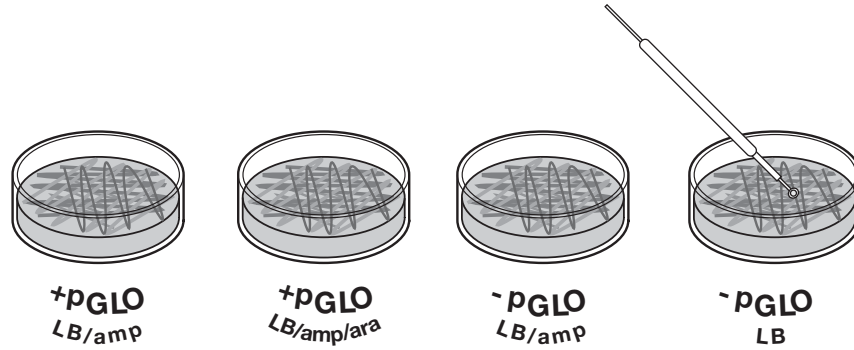

12. Stack up your plates and tape them together. Put your group name and class period on the bottom of the stack and place the stack of plates **upside down** in the 37°C incubator until the next day. The plates are inverted to prevent condensation on the lid which may drip onto the culture and interfere with your results.

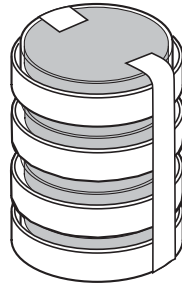





## Lesson 3 Data Collection and Analysis

### A. Data Collection

Observe the results you obtained from the transformation lab under normal room lighting. Then turn out the lights and hold the ultraviolet light over the plates. Alternatively the protocol can incorporate digital documentation of the plates with Vernier's Blue Digital BioImaging System (Appendix E).

1. Carefully observe and draw what you see on each of the four plates. Put your drawings in the data table below. Record your data to allow you to compare observations of the "+ pGLO" cells with your observations for the non-transformed *E. coli*. Write down the following observations for each plate.
2. How much bacterial growth do you see on each plate, relatively speaking?
3. What color are the bacteria?
4. How many bacterial colonies are on each plate (count the spots you see).

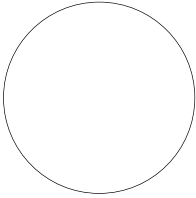
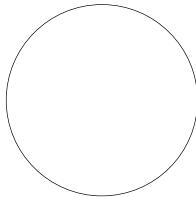
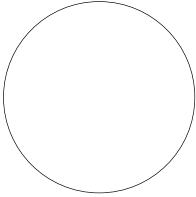
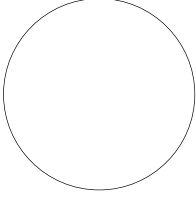
		Observations
Transformation plates	+pGLO LB/amp	
	+pGLO LB/amp/ara	
Control plates	-pGLO LB/amp	
	-pGLO LB	

## B. Analysis of Results

The goal of data analysis for this investigation is to determine if genetic transformation has occurred.

1. Which of the traits that you originally observed for *E. coli* did not seem to become altered? In the space below list these untransformed traits and how you arrived at this analysis for each trait listed.

**Original trait**

**Analysis of observations**

2. Of the *E. coli* traits you originally noted, which seem now to be significantly different after performing the transformation procedure? List those traits below and describe the changes that you observed.

**New trait**

**Observed change**

3. If the genetically transformed cells have acquired the ability to live in the presence of the antibiotic ampicillin, then what might be inferred about the other genes on the plasmid that you used in your transformation procedure?

4. From the results that you obtained, how could you prove that the changes that occurred were due to the procedure that you performed?

**Lesson 3 Review Questions**    Name \_\_\_\_\_

**What's Glowing?**

If a fluorescent green color is observed in the *E. coli* colonies then a new question might well be raised, "What are the two possible sources of fluorescence within the colonies when exposed to UV light?"

Explain:

1. Recall what you observed when you shined the UV light onto a sample of original pGLO plasmid DNA and describe your observations.
2. Which of the two possible sources of the fluorescence can now be eliminated?
3. What does this observation indicate about the source of the fluorescence?
4. Describe the evidence that indicates whether your attempt at performing a genetic transformation was successful or not successful.

**Lesson 3 Review Questions**    Name \_\_\_\_\_

**The Interaction between Genes and Environment**

Look again at your four plates. Do you observe some *E. coli* growing on the LB plate that does not contain ampicillin or arabinose?

1. From your results, can you tell if these bacteria are ampicillin resistant by looking at them on the LB plate? Explain your answer.
  
2. How would you change the bacteria's environment—the plate they are growing on—to best tell if they are ampicillin resistant?
  
3. Very often an organism's traits are caused by a combination of its genes and its environment. Think about the green color you saw in the genetically transformed bacteria:
  - a. What two factors must be present in the bacteria's environment for you to see the green color? (Hint: one factor is in the plate and the other factor is in how you look at the bacteria).
  
  - b. What do you think each of the two environmental factors you listed above are doing to cause the genetically transformed bacteria to turn green?
  
  - c. What advantage would there be for an organism to be able to turn on or off particular genes in response to certain conditions?

## Lesson 4 Extension Activity: Calculate Transformation Efficiency

Your next task in this investigation will be to learn how to determine the extent to which you genetically transformed *E. coli* cells. This quantitative measurement is referred to as the transformation efficiency.

In many experiments, it is important to genetically transform as many cells as possible. For example, in some types of gene therapy, cells are collected from the patient, transformed in the laboratory, and then put back into the patient. The more cells that are transformed to produce the needed protein, the more likely that the therapy will work. The transformation efficiency is calculated to help scientists determine how well the transformation is working.

### The Task

You are about to calculate the transformation efficiency, which gives you an indication of how effective you were in getting DNA molecules into bacterial cells. Transformation efficiency is a number. It represents the total number of bacterial cells that express the green protein, divided by the amount of DNA used in the experiment. (It tells us the total number of bacterial cells transformed by one microgram of DNA.) The transformation efficiency is calculated using the following formula:

$$\text{Transformation efficiency} = \frac{\text{Total number of colonies growing on the agar plate}}{\text{Amount of DNA spread on the agar plate (in } \mu\text{g)}}$$

Therefore, before you can calculate the efficiency of your transformation, you will need two pieces of information:

- (1) **The total number of green fluorescent colonies growing on your LB/amp/ara plate.**
- (2) **The total amount of pGLO plasmid DNA in the bacterial cells spread on the LB/amp/ara plate.**

### 1. Determining the Total Number of Green Fluorescent Cells

Place your LB/amp/ara plate near a UV light. Each colony on the plate can be assumed to be derived from a single cell. As individual cells reproduce, more and more cells are formed and develop into what is termed a colony. The most direct way to determine the **total number of bacteria that were transformed with the pGLO plasmid** is to count the colonies on the plate.

Enter that number here →

Total number of colonies =

\_\_\_\_\_

### 2. Determining the Amount of pGLO DNA in the Bacterial Cells Spread on the LB/amp/ara Plate

We need two pieces of information to find out the amount of pGLO DNA in the bacterial cells spread on the LB/amp/ara plate in this experiment. (a) What was the total amount of DNA we began the experiment with, and (b) What fraction of the DNA (in the bacteria) actually got spread onto the LB/amp/ara plates.

Once you calculate this data, you will multiply the **total amount of pGLO DNA** used in this experiment by the **fraction of DNA** you spread on the LB/amp/ara plate. This will tell you the amount of pGLO DNA in the bacterial cells that were spread on the LB/amp/ara plate.

#### a. Determining the Total Amount of pGLO plasmid DNA

The total amount of DNA we began with is equal to the product of the concentration and the total volume used, or

$$(\text{DNA in } \mu\text{g}) = (\text{concentration of DNA in } \mu\text{g}/\mu\text{l}) \times (\text{volume of DNA in } \mu\text{l})$$

In this experiment you used 10  $\mu\text{l}$  of pGLO at concentration of 0.08  $\mu\text{g}/\mu\text{l}$ . This means that each microliter of solution contained 0.08  $\mu\text{g}$  of pGLO DNA. Calculate the **total amount of DNA** used in this experiment.

Enter that number here →

**Total amount of pGLO DNA ( $\mu\text{g}$ )**  
used in this experiment =

\_\_\_\_\_

How will you use this piece of information?

- b. Determining the fraction of pGLO plasmid DNA (in the bacteria) that actually got spread onto the LB/amp/ara plate:** Since not all the DNA you added to the bacterial cells will be transferred to the agar plate, you need to find out what fraction of the DNA was actually spread onto the LB/amp/ara plate. To do this, divide the volume of DNA you spread on the LB/amp/ara plate by the total volume of liquid in the test tube containing the DNA. A formula for this statement is

$$\text{Fraction of DNA used} = \frac{\text{Volume spread on LB/amp plate } (\mu\text{l})}{\text{Total sample volume in test tube } (\mu\text{l})}$$

You spread 100  $\mu\text{l}$  of cells containing DNA from a test tube containing a total volume of 510  $\mu\text{l}$  of solution. Do you remember why there is 510  $\mu\text{l}$  total solution? Look in the laboratory procedure and locate all the steps where you added liquid to the reaction tube. Add the volumes.

Use the above formula to calculate the **fraction of pGLO plasmid DNA** you spread on the LB/amp/ara plate.

Enter that number here →

Fraction of DNA = _____
----------------------------

- How will you use this piece of information?

**So, how many micrograms of pGLO DNA did you spread on the LB/amp/ara plates?**

To answer this question, you will need to multiply the **total amount of pGLO DNA used** in this experiment by the **fraction of pGLO DNA** you spread on the LB/amp/ara plate.

$$\text{pGLO DNA spread in } \mu\text{g} = \text{Total amount of DNA used in } \mu\text{g} \times \text{fraction of DNA used}$$

Enter that number here →

pGLO DNA spread ( $\mu\text{g}$ ) = _____
----------------------------------------------

- What will this number tell you?



Look at all your calculations above. Decide which of the numbers you calculated belong in the table below. Fill in the following table.

Number of colonies on LB/amp/ara plate =	
Micrograms of pGLO DNA spread on the plates	

Now use the data in the table to calculate the efficiency of the pGLO transformation

$$\text{Transformation efficiency} = \frac{\text{Total number of colonies growing on the agar plate}}{\text{Amount of DNA spread on the agar plate (in } \mu\text{g)}}$$

Enter that number here →

Transformation efficiency = _____ transformants/ $\mu\text{g}$
-------------------------------------------------------------------

### Analysis

Transformation efficiency calculations result in very large numbers. Scientists often use a mathematical shorthand referred to as scientific notation. For example, if the calculated transformation efficiency is 1,000 bacteria/ $\mu\text{g}$  of DNA, they often report this number as:

**$10^3$  transformants/ $\mu\text{g}$**  ( $10^3$  is another way of saying  $10 \times 10 \times 10$  or 1,000)

- How would scientists report 10,000 transformants/ $\mu\text{g}$  in scientific notation?

Carrying this idea a little farther, suppose scientists calculated an efficiency of 5,000 bacteria/ $\mu\text{g}$  of DNA. This would be reported as:

**$5 \times 10^3$  transformants/ $\mu\text{g}$**  ( $5 \times 1,000$ )

- How would scientists report 40,000 transformants/ $\mu\text{g}$  in scientific notation?



- Calculate the transformation efficiency of the following experiment using the information and the results listed below.

**DNA plasmid concentration: 0.08  $\mu\text{g}/\mu\text{l}$**

**250  $\mu\text{l}$   $\text{CaCl}_2$  transformation solution**

**10  $\mu\text{l}$  pGLO plasmid solution**

**250  $\mu\text{l}$  LB broth**

**100  $\mu\text{l}$  cells spread on agar**

**227 colonies of transformants**

Fill in the following chart and show your calculations to your teacher:

Number of colonies on LB/amp/ara plate =
Micrograms of DNA spread on the plates =
Transformation efficiency =

- Extra Credit Challenge:

If a particular experiment were known to have a transformation efficiency of  $3 \times 10^3$  bacteria/ $\mu\text{g}$  of DNA, how many transformant colonies would be expected to grow on the LB/amp/ara plate? You can assume that the concentration of DNA and fraction of cells spread on the LB agar are the same as that of the pGLO laboratory.

## Appendix A

### Historical Links to Biotechnology

Biological transformation has had an interesting history. In 1928, Frederick Griffith, a London physician working in a pathology laboratory, conducted an experiment that he would never be able to fully interpret as long as he lived. Griffith permanently changed (transformed) a safe, nonpathogenic bacterial strain of pneumococcus into a deadly pathogenic strain. He accomplished this amazing change in the bacteria by treating the safe bacteria with heat-killed deadly bacteria. In this mixture of the two bacterial strains there were no living, virulent bacteria, but the mixture killed the mice it was injected into. He repeated the experiment many times, always with the same results. He and many of his colleagues were very perplexed. What transformed safe bacteria into the deadly killers? Many years later, this would come to be known as the first recorded case of biological transformation conducted in a laboratory, and no one could explain it. Griffith did not know of DNA, but knew the transformation was inheritable. As any single point in history can be, Griffith's experiments in transformation can be seen as the birth of analytical genetic manipulation that has led to recombinant DNA and biotechnology, and the prospects for human gene manipulation.

In 1944, sixteen years after Griffith's experiment, a research group at Rockefeller Institute, led by Oswald T. Avery, published a paper that came directly from the work of Griffith. "What is the substance responsible?" Avery would ask his coworkers. Working with the same strains of pneumonia-causing bacteria, Avery and his coworkers provided a rigorous answer to that question. They proved that the substance is DNA, and that biological transformation is produced when cells take up and express foreign DNA. Although it took many years for credit to be given to Avery, today he is universally acknowledged for this fundamental advance in biological knowledge. Building upon the work of Avery and others, Douglas Hanahan developed the technique of colony transformation used in this investigation.<sup>1, 2</sup>

#### Historical Context

##### *Genetic Transformation*

1865—Gregor Johann Mendel: Mendel presented his findings describing the principles by which genetic traits are passed from parent to offspring. From his work the concept of the gene as the basic unit of heredity was derived.

1900—Carl Correns, Hugo De Vries, Erich Tschermak: Plant geneticists conducting inheritance studies uncovered that their work was essentially a duplicate of work performed nearly four decades earlier by an unknown Austrian Augustinian monk, Gregor Johann Mendel, who studied peas.

1928—Frederick Griffith: Griffith transformed nonpathogenic *Diplococcus pneumonia* into pathogenic bacteria using heat-killed virulent bacteria. He suggested that the transforming factor had something to do with the polysaccharide capsule synthesis. Griffith did not know of DNA, but knew the transformation was inheritable. Griffith's experiments in transformation can be seen as the birth of analytical genetic manipulation that has led to recombinant DNA technology and the prospects for human gene manipulation.

- 1944—Oswald Avery, Colin MacLeod: Avery and his colleagues announced that they had isolated the transforming factor to a high purity, and it was DNA. Since this classic experiment in molecular genetics, transformation, conjugation (bacterial mating), and transduction (viral DNA transfer) have been used to transfer genes between species of bacteria, *Drosophila*, mice, plants and animals, mammalian cells in culture, and for human gene therapy.
- 1952—Alfred Hershey, Martha Chase: Hershey and Chase used radioisotopes of sulfur and phosphorus, and bacteriophage T2 to show conclusively that DNA was the information molecule of heredity. Along with the work of Avery, MacLeod, and McCarty, the Hershey/Chase experiment sealed the understanding that DNA was the transforming material and the information molecule of heredity.
- 1972—Paul Berg, Janet Mertz: Berg used the newly discovered endonuclease enzyme, *EcoRI*, to cut SV40 DNA and bacteriophage P22 DNA, and then used terminal transferase enzyme and DNA ligase to rejoin these separate pieces into one piece of DNA. Creation of the first recombinant DNA molecule was the beginning of the age of biotechnology. The new molecule was not placed inside a mammalian cell because of concerns in the scientific community regarding genetic transfers.
- 1973—Herbert Boyer, Stanley Cohen, Annie Chang: Berg, Boyer, and Cohen used *EcoRI* to isolate an intact gene for kanamycin resistance. Boyer, Cohen, and Chang spliced the kanamycin resistance gene into an *EcoRI* cut plasmid that already contained tetracycline resistance and produced a recombinant bacterial plasmid molecule with dual antibiotic resistance. They then transformed *E. coli* with this engineered plasmid.
- 1977—Genentech, Inc.: The first product of genetic engineering, the gene for human somatostatin (human growth hormone-releasing inhibitory factor), was expressed in bacteria and announced by Genentech.
- 1980—J. W. Gordon, Frank Ruddle: Gordon and Ruddle successfully microinjected normal genes into mouse germ-line cells.
- 1982—Richard Palmiter, Ralph Brinster: Palmiter and Brinster microinjected the gene for rat growth hormone into mice embryos. This was the first genetic germ-line “cure” reported in a mammal. The recipient mouse was called “little” because it suffered from a form of congenital dwarfism.
- 1988—Steven Rosenberg: Rosenberg and his colleagues were given approval to perform the first gene transfer experiment in human patients suffering from metastatic melanoma. This experiment represented genetic tracking with the marker gene Neo<sup>R</sup> and not gene therapy.
- 1990—W. French Anderson, Michael Blaese, Kenneth Culver: At 12:52 p.m. on Friday, September 14, 1990 at the National Cancer Institute, a four year old girl, Ashanthi De Silva from Cleveland, Ohio, became the first human gene-therapy patient. She was infused with her own white blood cells carrying the corrected version of the adenosine deaminase (ADA) gene. Drs. Anderson, Blaese and Culver did not expect meaningful results from the experiment for about 1 year. A second girl, Cynthia Cutshall, was similarly injected in 1990. Reports in June 1993 showed the two girls with smiles and childish energy, playing in a school yard. Both girls’ immune systems were working effectively.
- 1994—Other gene therapy candidates include sickle cell anemia, hemophilia, diabetes, cancer, and heart disease patients. Germ line gene therapy is debated during meeting of the Recombinant DNA Advisory Committee. By 1996 a growing number of proposals await review by the Human Gene Therapy Subcommittee of the Recombinant DNA Advisory Committee.

1995—Led by J. Craig Venter, a group at The Institute for Genomic Research (TIGR) in Maryland, published the full gene sequence of the bacterium *Hemophilus influenzae*, a landmark in microbiological research as the first free-living organism whose genetic “blueprint” was decoded.

1996—A multinational collaboration including more than 100 laboratories from Europe, USA, Canada, and Japan was the first to unravel the entire genome sequence of a eukaryote, the yeast *Saccharomyces cerevisiae*. *S. cerevisiae* is a commercially significant yeast commonly used in baking and in fermentation of alcoholic beverages and is widely used in the laboratory as a model organism for understanding cellular and molecular processes of eukaryotes.

1997—Scientists led by Ian Wilmut at Scotland’s Roslin Institute reported the successful cloning of a sheep, named Dolly, from the cell of an adult udder cell. The cloning of Dolly sparked international debate about ethical and moral issues concerning cloning. Subsequently, scientists at Scotland’s Roslin Institute, in collaboration with Scotland-based PPL Therapeutics, successfully cloned two genetically modified lambs, named Polly and Molly, that were genetically modified with a human gene so that their milk contained a protein called factor IX, a blood-clotting protein that can be extracted and used in treating human hemophilia.

1998—Over 99% of the genome sequence of the first multicellular organism, the tiny roundworm *Caenorhabditis elegans*, was reported. Although *C. elegans* is a primitive organism, it shares many of its essential genetic and biological characteristics with humans and may help scientists identify and characterize the genes involved in human biology and disease.

Scientists produced a detailed and accurate physical map, or location, for most of the 30,000 known human genes, a milestone for the Human Genome Project.

2000—A team led by Ingo Potrykus of the Swiss Federal Institute of Technology in Zurich and Peter Beyer of the University of Freiburg in Germany reported the creation of genetically modified rice called “golden rice”, which can produce large amounts of beta-carotene, a substance that human beings can turn into Vitamin A. “Golden rice” could alleviate blindness caused by vitamin A deficiency in millions of poverty-stricken people around the world.

The genome sequence of the fruit fly *Drosophila melanogaster* was published through a collaboration between a private company, Celera Genomics, and researchers worldwide studying the fruit fly. *D. melanogaster*, a model widely used in the laboratory, is the largest animal so far to have its genetic code deciphered.

A rough draft of the human genome was completed by a team of 16 international institutions that form the Human Genome Sequencing Consortium. Researchers at Celera Genomics also announced completion of their ‘first assembly’ of the genome.

2001—On February 12, 2001, Celera Genomics and the International Human Genome Sequencing Consortium jointly announced the publishing of the nearly complete sequence of the human genome - the genetic “blueprint” for a human being. This accomplishment took the international team almost twenty years and involved the collaboration of thousands of scientists from around the world. Celera Genomics reported completing the work in approximately nine months. The two groups differed in their estimates for the number of genes in the human genome, but the range predicted by both groups, between 25,000 and 40,000 genes, is far fewer than the previous estimate of 100,000 genes. This unexpected finding suggested that an organism as complex as a human being can be made of so few genes, only twice as many as found in the worm *C. elegans* or the fly *D. melanogaster*. The unveiling of the full sequence of the human genome makes it possible for researchers all over the world to begin developing treatments for many diseases.

President George Bush decided that only experiments involving the existing 64 embryonic stem cell lines would be eligible for possible federal funding. The president’s decision was disappointing to many scientists who hoped to use embryonic stem cells to develop treatments for many ailments.

Advanced Cell Technology, a small company in Massachusetts, announced that it had successfully cloned human embryos for the purpose of extracting their stem cells. This method could ultimately be used to treat patients with a variety of diseases by making replacement cells, such as nerve and muscle cells, which can be transplanted back into same person without the risk of being rejected by the body.

PPL Therapeutics, the company that helped to clone Dolly the sheep, announced that it had cloned five genetically modified piglets with an inactivated, or “knocked out”, gene that would make their organs much less likely to be rejected when transplanted into a human recipient. The success of PPL Therapeutics brings hope to the thousands of people who are waiting to receive donated organs such as hearts, lungs, kidneys, and livers.

2002—Dolly the sheep, the first mammal to be cloned from an adult cell, developed arthritis at a relatively early age of five years. It is not clear whether Dolly’s condition was the result of a genetic defect caused by cloning, or whether it was a mere coincidence. The news has renewed debates on whether cloned animals are susceptible to premature aging and health problems and has also been a setback for those who argue that cloning can be used to generate a supply of organs to help patients on the transplant list.

2008—Discovery and landmark developmental uses of GFP wins the Nobel Prize in Chemistry. Osamu Shimonura was the first to isolate GFP and found that it had fluorescent properties when exposed to UV light. Martin Chalfie used GFP as a luminous genetic tag. Roger Y. Tsien uncovered GFP’s fluorescent mechanism.

## Appendix B Glossary of Terms

<b>Agar</b>	A gelatinous substance derived from seaweed. Provides a solid matrix to support bacterial growth. Contains nutrient mixture of carbohydrates, amino acids, nucleotides, salts, and vitamins.
<b>Antibiotic Selection</b>	Use of an antibiotic to select bacteria containing the DNA of interest. The pGLO plasmid DNA contains the gene for beta-lactamase that provides resistance to the antibiotic ampicillin. Once bacteria are transformed with the pGLO plasmid, they begin producing and secreting beta-lactamase protein. Secreted beta-lactamase breaks down ampicillin, rendering the antibiotic harmless to the bacterial host. Only bacteria containing the pGLO plasmid can grow and form colonies in nutrient medium containing ampicillin, while untransformed cells that have not taken up the pGLO plasmid cannot grow on the ampicillin selection plates.
<b>Arabinose</b>	A carbohydrate isolated from plants that is normally used as source of food by bacteria. In this experiment, arabinose initiates transcription of the GFP gene resulting in fluorescent green cells under UV light.
<b>Beta-Lactamase</b>	Beta-lactamase is a protein that provides resistance to the antibiotic ampicillin. The beta-lactamase protein is produced and secreted by bacteria that have been transformed with a plasmid containing the gene for beta-lactamase. The secreted beta-lactamase inactivates the ampicillin present in the LB nutrient agar, which allows for bacterial growth and expression of newly acquired genes also contained on the plasmid, such as GFP.
<b>Biotechnology</b>	Applying biology in the real world by the specific manipulation of living organisms, especially at the genetic level, to produce potentially beneficial products.
<b>Cloning</b>	Cloning is the process of generating virtually endless copies or clones of an organism or segment of DNA. Cloning produces a population that has an identical genetic makeup.
<b>Colony</b>	A clump of genetically identical bacterial cells growing on an agar plate. Because all the cells in a single colony are genetically identical, they are called clones.
<b>Culture Media</b>	The liquid and solid media referred to as LB (named after Luria and Bertani) broth and agar are made from an extract of yeast and an enzymatic digest of meat byproducts which provide a mixture of carbohydrates, amino acids, nucleotides, salts, and vitamins, all of which are nutrients for bacterial growth. Agar, which is from seaweed, polymerizes when heated and cooled to form a solid gel (similar to Jell-O gelatin), and functions to provide a solid support on which to culture the bacteria.
<b>Genetic Engineering</b>	The manipulation of an organism's genetic material (DNA) by introducing or eliminating specific genes.



**Gene Regulation**

Gene expression in all organisms is carefully regulated to allow for differing conditions and to prevent wasteful overproduction of unneeded proteins. The genes involved in the transport and breakdown of food are good examples of highly regulated genes. For example, the simple sugar, arabinose, can be used as a source of energy and carbon by bacteria. The bacterial enzymes that are needed to break down or digest arabinose for food are only expressed in the absence of arabinose but are expressed when arabinose is present in the environment. In other words when arabinose is around, the genes for these digestive enzymes are turned on. When arabinose runs out these genes are turned back off. See Appendix D for a more detailed explanation of the role that arabinose plays in the regulation and expression of the Green Fluorescent Protein gene.

**Green Fluorescent Protein**

Green Fluorescent Protein (GFP) was originally isolated from the bioluminescent jellyfish, *Aequorea victoria*. The gene for GFP has recently been cloned. The unique three-dimensional conformation of GFP causes it to resonate when exposed to ultraviolet light and give off energy in the form of visible green light. When exposed to UV light, the electrons in GFP's chromophore are excited to a higher energy state. When they drop down to a lower energy state, they emit a longer wavelength of visible fluorescent green light at ~509 nm.

**Plasmid**

A circular DNA molecule, capable of self-replicating, carrying one or more genes for antibiotic resistance proteins and a cloned foreign gene such as GFP. It is an extra-chromosomal DNA molecule separate from the chromosomal DNA. Plasmids usually occur naturally in bacteria.

**pGLO**

Plasmid containing the Green Fluorescent Protein gene sequence and ampicillin resistance gene, which codes for beta-lactamase.

**Recombinant DNA Technology**

The process of cutting and recombining DNA fragments as a means to isolate genes or to alter their structure and function.

**Screening**

Process of identifying wanted bacteria from a bacterial library.

**Sterile Technique**

Minimizing the possibility of outside bacterial contamination during an experiment through observance of cleanliness and using careful laboratory techniques.

**Streaking**

Process of passing an inoculating loop with bacteria on it across an agar plate in quadrants with the intent of generating single colonies.

**Vector**

An autonomously replicating DNA molecule, such as a plasmid, into which foreign DNA fragments are inserted and then propagated in a host cell.

## **Appendix C**

### **Basic Molecular Biology Concepts and Terminology**

A study of the living world reveals that all living organisms organize themselves in some unique fashion. A detailed blueprint of this organization is passed on to offspring.

Cells are the smallest functional units capable of independent reproduction. Many bacteria, for instance, can survive as single cells. The chemical molecules within each cell are organized to perform in concert.

#### **Cells can be grown in culture and harvested**

Cell culture is the process by which cells can be gathered from their natural locations and grown inside laboratory containers under controlled conditions. Appropriate food and environment must be provided for the cells to grow. Bacteria and yeast are very easy to grow in culture. Cells taken from plants, insects and animals can also be grown, but are more difficult to care for.

After growth is complete, cells in culture can be harvested and studied.

#### **Cloning**

When a population of cells is prepared by growth from a single cell, all the cells in the population will be genetically identical. Such a population is called clonal. The process of creating a clonal population is called cloning. The purpose of streaking bacteria on agar is to generate single colonies, each arising from a single cell.

#### **Looking inside cells**

The molecules inside a cell each perform a given function. For instance, DNA molecules store information (like the hard drive in a computer). Proteins are the workhorses of the cell.

To study these molecules we prepare a clonal population from a cell type of interest, break open the cells and sort the contents. For instance, it is fairly easy to separate all the proteins from all the DNA molecules.

Purifying a single species of protein out of the mixture of proteins found inside a cell type is also possible. Each type of protein has unique physical and chemical properties. These properties allow the separation of protein species based on size, charge, or hydrophobicity, for instance.

#### **Special molecules, specialized functions**

We will take a close look at three very special kinds of molecules found inside cells: DNA, RNA and proteins. Each of these molecules performs a different function. DNA molecules are like file cabinets in which information is stored. RNA helps to retrieve and execute the instructions which are stored in DNA. Proteins are designed to perform chemical chores inside (and often outside) the cell.

#### **DNA—The universal template for biological information**

The master script for each organism is encoded within its deoxyribonucleic acid (DNA). The information within the DNA molecule/s of each cell is sufficient to initiate every function that cell will perform.

DNA molecules are very long chains composed of repeating subunits. Each subunit (nucleotide) contains one of four possible bases protruding from its side:

adenine (**A**)  
thymine (**T**)

cytosine (**C**)  
guanine (**G**)

Since nucleotides are joined head-to-tail, a long strand of DNA essentially consists of a chemical backbone with bases protruding along its side. The information carried by this molecule is encoded in the sequence of the bases **A**, **G**, **C**, and **T** along its length.

### Some further points to note about DNA structure

1. Because the subunits of DNA chains are joined head-to-tail, the sequence is directional. By convention, we write DNA sequence from the free 5' (pronounced "5 prime") end of the backbone and work our way toward the other end, the "3 prime" end, or 3'.

*i.e.* 5'...**AACTG**...3'

2. The protruding bases along the chain are free to form spontaneous hydrogen bonds with available bases on other DNA strands according to the following rules:

- (i) **A** pairs with **T**
- (ii) **C** pairs with **G**

Because of these rules, **A** and **T** are said to be complementary bases; **G** and **C** are also complementary.

- (iii) For two DNA strands to pair up, they must be complementary and run in opposite directions.

*i.e.* (5'...**AGGTC**...3') can pair with (5'...**GACCT**...3'). These two strands have complementary sequences. The double-stranded pair is written as follows:

5'...**AGGTC**...3'  
3'...**TCCAG**...5'

The above molecule contains five base pairs. Indeed, in nature, DNA almost always occurs in double-stranded form with the two strands containing complementary sequences.

3. DNA molecules are typically thousands, sometimes millions of base pairs long. Sometimes the two ends of a DNA molecule are joined to form circular DNA.
4. Double-stranded DNA, in its native form, occurs as a coiled spring, or helix. Because it is two-stranded, it is often referred to as a double helix.

The architecture of DNA allows for a very simple strategy during reproduction: The two strands of each DNA molecule unwind and "unzip"; then, each strand allows a new complementary copy of itself to be made by an enzyme called DNA polymerase. This results in two daughter molecules, each double-stranded, and each identical to the parent molecule.

### Proteins and RNA are the workhorses of the cell

The biochemistry of life requires hundreds of very specific and efficient chemical interactions, all happening simultaneously. The major players in these interactions are short-lived protein and RNA molecules which can work together or independently to serve a variety of functions. Like DNA, RNA and proteins are also long chains of repeating units.

#### RNA

RNA (ribonucleic acid), like DNA, consists of four types of building blocks strung together in a chain. It differs from DNA in the following respects:

The four bases in RNA are **A**, **G**, **C**, and **U** (uracil); the pairing rules are the same as for DNA except that **A** pairs with **U**. Although RNA can pair with complementary RNA or DNA, in cells RNA is usually single-stranded. The sugar in the RNA backbone is ribose, not deoxyribose. RNA molecules are generally short, compared to DNA molecules; this is because each RNA is itself a copy of a short segment from a DNA molecule. The process of copying segments of DNA into RNA is called transcription, and is performed by a protein called RNA polymerase.

### Proteins

Proteins (more precisely, polypeptides) are also long, chain-like molecules but are more structurally diverse than either DNA or RNA. This is because the subunits of proteins, called amino acids, come in twenty different types. The exact sequence of amino acids along a polypeptide chain determines how that chain will fold into its three-dimensional structure. The precise three-dimensional features of this structure, in turn, determine its function.

What a protein will **do** depends on the exact **sequence** of its amino acids.

In most cases, a protein will perform a single function. Very diverse functions can be performed by proteins: Some proteins, called enzymes, act as catalysts in chemical reactions; some carry signals from one part of a cell to another—or, in the case of “hormones”, from one cell to another; some proteins (antibodies) have the task of fighting intruders; many become integral parts of the various physical structures inside cells; and still others (regulatory proteins) police various activities within cells so as to keep them within “legal” limits.

### Linear code, three-dimensional consequences

DNA is the primary depot for information in living systems. As mentioned, this information is linear, *i.e.*, encoded in the sequence of **A**, **G**, **C**, **T** building blocks along the DNA molecule. This linear code can be passed on to offspring—because DNA can be replicated in exact copies.

Short segments of each DNA molecule are chosen for transcription at any given time. These segments are called genes. The enzyme, RNA polymerase, copies the entire segment, base by base, assembling an RNA molecule which contains a sequence of **A**, **G**, **C** and **U** exactly complementary to the DNA sequence of the transcribed gene.

In addition to providing a master template for copying RNAs, DNA also contains sequence information which tells the RNA polymerase where to start transcribing a gene (promoter) and where to stop, how many copies it should make and when, and it can even embed certain information within the RNA sequence to determine the longevity and productivity of that RNA.

There are three major classes of RNAs copied off DNA templates: messenger RNAs, or mRNAs, which relay the sequence information required for assembling proteins; transfer RNAs, or tRNAs, which work in the assembly line for proteins; and RNAs which perform structural functions. For example, ribosomal RNAs, or rRNAs, help build the scaffolding for ribosomes, the factories where proteins are assembled.

mRNAs carry the sequence information for making proteins. Ribosomes read this sequence of nucleotides, by a process called “translation”, into a sequence of amino acids. How is this accomplished? There are only four kinds of nucleotides, but twenty kinds of amino acids.

During translation, the ribosome reads 3 nucleotides at a time and assigns an amino acid to each successive triplet. **Note:** Triplets are often referred to as **codons**. Each amino acid is then attached to the end of the growing protein chain. There are 64 possible triplets,

or codons. Thus, the linear information residing in DNA is used to assemble a linear sequence of amino acids in a protein. This sequence, in turn, **will determine the way that protein will fold into a precise shape** with characteristic chemical properties.

In summary, the primary transfer of information within cells follows the order:

DNA→RNA→PROTEIN→TRAIT

Although the information itself is linear, the implications are three-dimensional. A fundamental assumption of recombinant DNA technology is that permanent and desirable changes in the functioning of living cells can be accomplished by changing the linear sequence of their DNA.

### **Genes are discrete files of DNA information**

A gene is a segment within a DNA molecule singled out for copying into RNA. Directly or indirectly, this RNA will perform a function. It is convenient to think of a gene, therefore, as a unit of function.

Many traits, such as bacterial resistance to an antibiotic, are governed by single genes. Most traits—such as the color of a rose, or the shape of a nose—are governed by several genes acting in concert.

Genes can vary in length: Some are only a few hundred base pairs long; some can be tens of thousands of base pairs long. A DNA molecule may carry from a handful to thousands of genes. A cell, in turn, may contain one or several DNA molecules (chromosomes). Thus the number of genes in a cell can vary greatly. *E. coli*, a bacterium, contains one DNA molecule with about 5,000 genes on it. A human cell contains 46 DNA molecules carrying a total of about 100,000 genes.

All genes in a given cell are **not** copied into RNA (*i.e.* “expressed”) at the same time or at the same rate. Thus, when speaking of gene function, one refers to its expression level. This rate can be controlled by the cell, according to predetermined rules which are themselves written into the DNA.

An example: The cells in our bodies (all 100 trillion of them) each contain identical DNA molecules. Yet liver cells, for example, express only those genes required for liver function, whereas skin cells express a quite different subset of genes.

### **DNA can be cut into pieces with restriction enzymes**

Restriction enzymes are proteins made by bacteria as a defense against foreign, invading DNA (for example, viral DNA). Each restriction enzyme recognizes a unique sequence of typically 4–6 base pairs, and will cut any DNA whenever that sequence occurs.

For example, the restriction enzyme *Bam*H I recognizes the sequence (5'..GGATCC..3') and cuts the DNA strand between the two **G** nucleotides in that sequence.

Restriction enzymes will cut DNA from any source, provided the recognition sequence is present. It does not matter if the DNA is of bacterial, plant or human origin.

### **Pieces of DNA can be joined by DNA ligase**

DNA ligase is an enzyme that glues pieces of DNA together, provided the ends are compatible.

Thus, a piece of human or frog or tomato DNA cut with *Bam*H I can be easily joined to a piece of bacterial DNA also cut with *Bam*H I. This allows the creation of recombinant DNAs, or hybrids, created by joining pieces of DNA from two different sources.

Genes can be cut out of human DNA or plant DNA, and placed inside bacteria. For example, the human gene for the hormone insulin can be put into bacteria. Under the right conditions, these bacteria can make authentic human insulin.

### **Plasmids are small circular pieces of DNA**

Plasmids are small circular DNAs found inside some bacterial cells. They replicate their own DNA by borrowing the cells' polymerases. Thus they can persist indefinitely inside cells without doing very much work of their own.

Because of their small size, plasmid DNAs are easy to extract and purify from bacterial cells. When cut with a restriction enzyme, they can be joined to foreign DNAs—from any source—which have been cut with the same enzyme.

The resulting hybrid DNAs can be reintroduced into bacterial cells by a procedure called transformation. Now the hybrid plasmids can perpetuate themselves in the bacteria just as before except that the foreign DNA which was joined to it is also being perpetuated. The foreign DNA gets a free ride, so to speak.

Every hybrid plasmid now contains a perfect copy of the piece of foreign DNA originally joined to it. We say that foreign piece of DNA has been cloned; the plasmid which carried the foreign DNA is called a cloning vehicle or vector.

In addition to their usefulness for cloning foreign genes, plasmids sometimes carry genes of their own. Bacteria die when exposed to antibiotics. However, antibiotic-resistance genes allow bacteria to grow in the presence of an antibiotic such as ampicillin. Such genes are often found on plasmids. When foreign DNA is inserted into such plasmids, and the hybrids introduced into bacterial cells by transformation, it is easy to select those bacteria that have received the plasmid—because they have acquired the ability to grow in the presence of the antibiotic, whereas all other bacterial cells are killed.

### **DNA libraries**

When DNA is extracted from a given cell type, it can be cut into pieces and the pieces can be cloned en masse into a population of plasmids. This process produces a population of hybrid (recombinant) DNAs. After introducing these hybrids back into cells, each transformed cell will have received and propagated one unique hybrid. Every hybrid will contain the same vector DNA but a different insert DNA.

If there are 1,000 different DNA molecules in the original mixture, 1,000 different hybrids will be formed; 1,000 different transformant cells will be recovered, each carrying one of the original 1,000 pieces of genetic information. Such a collection is called a DNA library. If the original extract came from human cells, the library is a human library.

Individual DNAs of interest can be fished out of such a library by screening the library with an appropriate probe.

## Appendix D Gene Regulation

Our bodies contain thousands of different proteins which perform many different jobs. Digestive enzymes are proteins; some of the hormone signals that run through our bodies and the antibodies protecting us from disease are proteins. The information for assembling a protein is carried in our DNA. The section of DNA which contains the code for making a protein is called a gene. There are over 30,000–100,000 genes in the human genome. Each gene codes for a unique protein: one gene, one protein. The gene that codes for a digestive enzyme in your mouth is different from one that codes for an antibody or the pigment that colors your eyes.

Organisms regulate expression of their genes and ultimately the amounts and kinds of proteins present within their cells for a myriad of reasons, including developmental changes, cellular specialization, and adaptation to the environment. Gene regulation not only allows for adaptation to differing conditions, but also prevents wasteful overproduction of unneeded proteins which would put the organism at a competitive disadvantage. The genes involved in the transport and breakdown (catabolism) of food are good examples of highly regulated genes. For example, the sugar arabinose is both a source of energy and a source of carbon. *E. coli* bacteria produce three enzymes (proteins) needed to digest arabinose as a food source. The genes which code for these enzymes are not expressed when arabinose is absent, but they are expressed when arabinose is present in their environment. How is this so?

Regulation of the expression of proteins often occurs at the level of transcription from DNA into RNA. This regulation takes place at a very specific location on the DNA template, called a promoter, where RNA polymerase sits down on the DNA and begins transcription of the gene. In bacteria, groups of related genes are often clustered together and transcribed into RNA from one promoter. These clusters of genes controlled by a single promoter are called operons.

The three genes (*araB*, *araA* and *araD*) that code for three digestive enzymes involved in the breakdown of arabinose are clustered together in what is known as the arabinose operon.<sup>3</sup> These three proteins are dependent on initiation of transcription from a single promoter, P<sub>BAD</sub>. Transcription of these three genes requires the simultaneous presence of the DNA template (promoter and operon), RNA polymerase, a DNA binding protein called *araC* and arabinose. *araC* binds to the DNA at the binding site for the RNA polymerase (the beginning of the arabinose operon). When arabinose is present in the environment, bacteria take it up. Once inside, the arabinose interacts directly with *araC* which is bound to the DNA. The interaction causes *araC* to change its shape which in turn promotes (actually helps) the binding of RNA polymerase and the three genes *araB*, *A* and *D*, are transcribed. Three enzymes are produced, they break down arabinose, and eventually the arabinose runs out. In the absence of arabinose the *araC* returns to its original shape and transcription is shut off.

The DNA code of the pGLO plasmid has been engineered to incorporate aspects of the arabinose operon. Both the promoter (P<sub>BAD</sub>) and the *araC* gene are present. However, the genes which code for arabinose catabolism, *araB*, *A* and *D*, have been replaced by the single gene which codes for GFP. Therefore, in the presence of arabinose, *araC* protein promotes the binding of RNA polymerase and GFP is produced. Cells fluoresce brilliant green as they produce more and more GFP. In the absence of arabinose, *araC* no longer facilitates the binding of RNA polymerase and the GFP gene is not transcribed. When GFP is not made, bacteria colonies will appear to have a wild-type (natural) phenotype—of white colonies with no fluorescence.

This is an excellent example of the central molecular framework of biology in action:  
DNA→RNA→PROTEIN→TRAIT.

## The Arabinose Operon

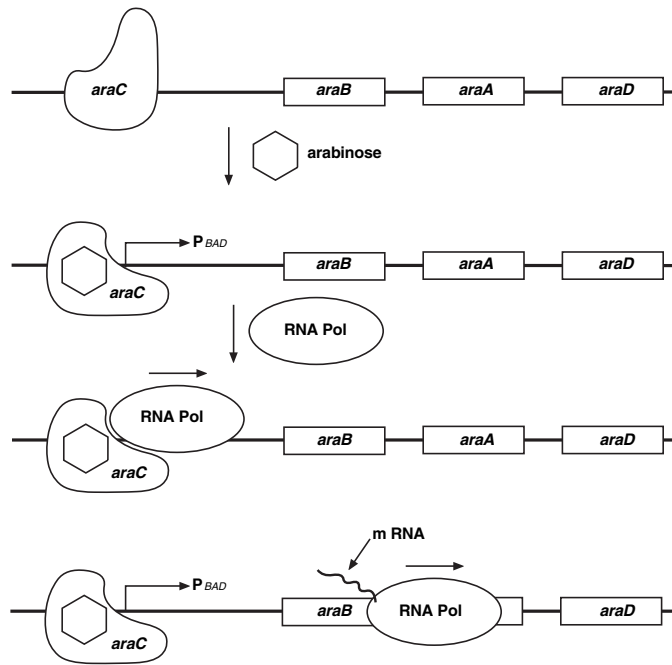

## Expression of Green Fluorescent Protein

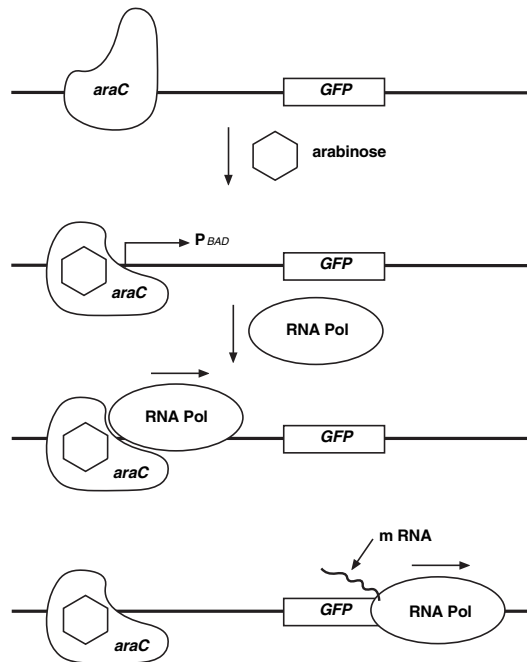



## Appendix E

### Photodocumentation of pGLO Plates Using Vernier's BlueView Transilluminator

1. Start Logger *Pro*<sup>®</sup> and choose New from the File menu.
2. Prepare the BlueView Transilluminator.
  - a. Transfer the +pGLO LB/amp plate to the central portion of the blue platform of the BlueView Transilluminator.
  - b. Connect the BlueView Transilluminator to AC power and turn it on.
3. Positioning the ProScope HR<sup>™</sup>.
  - a. Connect the 1–10X lens to the ProScope.
  - b. Connect the ProScope to the USB port.
  - c. Mount the ProScope to the stand and position the stand next to the transilluminator.
  - d. Level the ProScope so that its lens is parallel to the surface of the transilluminator.
4. Prepare Logger *Pro* for use.
  - a. Choose Add Page ► Blank Page ► OK from the Page menu.
  - b. Choose Text from the Insert menus and enter a title to describe the test, for example “+ pGLO, Colonies LB amp/ara.”
  - c. Choose Video Capture ► Take Photo from the Insert menu.
  - d. Orient and focus the ProScope HR so that colonies are sharply focused.
5. Place the Imaging Hood over the ProScope and the transilluminator. Reach through the flap of the hood to make final adjustments for best position, focus, and resolution.
6. When you are satisfied with the image, click on Take Photo and choose Auto Arrange from the Page menu.
7. The screen should now resemble Figure 1.
8. Add a new page and title for the next plate and take its photo.
9. Repeat for each subsequent plate.
10. Colony count data and plate information can be added to page 1 data table (optional).

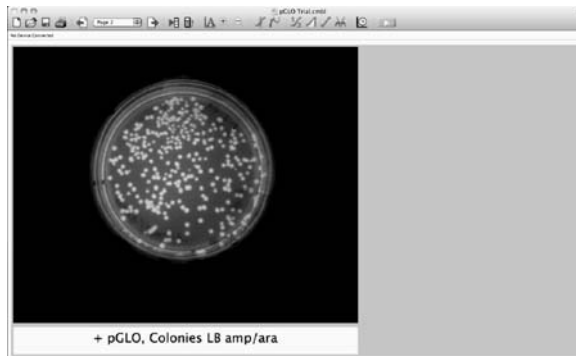

Figure 1

## Appendix F References

1. Hanahan, Douglas, Studies on transformation of *Escherichia coli* with plasmids. *J. Mol. Biol.*, **166**, 557 (1983).
2. Hanahan, Douglas, Techniques for transformation of *E. coli*. In DNA Cloning: A Practical Approach (Ed. D. M. Glover), vol. 1. IRL Press, Oxford (1987).
3. Schleif, Robert, Two positively regulated systems, *ara* and *mal*, In *Escherichia coli* and *Salmonella*, Cellular and Molecular Biology, Neidhardt. ASM Press, Washington, D.C. (1996).

Parafilm is a trademark of American National Can Co.

Jell-O is a trademark of Kraft Foods, Inc.

Logger *Pro* is a trademark of Vernier Software & Technology.

Pro Scope HR is a trademark of Bodelin Technologies.





Bio-Rad  
Laboratories, Inc.

Life Science  
Group

Web site [www.bio-rad.com](http://www.bio-rad.com) USA 800 424 6723 Australia 61 2 9914 2800 Austria 01 877 89 01 Belgium 09 385 55 11 Brazil 55 31 3689 6600  
Canada 905 364 3435 China 86 20 8732 2339 Czech Republic 420 241 430 532 Denmark 44 52 10 00 Finland 09 804 22 00 France 01 47 95 69 65  
Germany 089 31 884 0 Greece 30 210 777 4396 Hong Kong 852 2789 3300 Hungary 36 1 459 6100 India 91 124 4029300 Israel 03 963 6050  
Italy 39 02 216091 Japan 03 6361 7000 Korea 82 2 3473 4460 Mexico 52 555 488 7670 The Netherlands 0318 540666 New Zealand 0508 805 500  
Norway 23 38 41 30 Poland 48 22 331 99 99 Portugal 351 21 472 7700 Russia 7 495 721 14 04 Singapore 65 6415 3188 South Africa 27 861 246 723  
Spain 34 91 590 5200 Sweden 08 555 12700 Switzerland 061 717 95 55 Taiwan 886 2 2578 7189 United Kingdom 020 83282000



P1660033EDU

166-0033EDU Biotechnology Explorer™  
pGLO™ Bacterial Transformation Kit

Sig 1109

1660033EDU Rev G